



## LIVING WITH SLOPE MASS MOVEMENTS IN SLOVENIA AND ITS SURROUNDINGS

SATURDAY 3 JUNE – MONDAY 5 JUNE, 2017

Univerza v Ljubljani



ISBN 978-961-6884-47-1



9 781234 567897



**4TH WORLD LANDSLIDE FORUM**

**POST FORUM STUDY TOUR GUIDE BOOK:**

**LIVING WITH SLOPE MASS MOVEMENTS IN SLOVENIA AND ITS SURROUNDINGS**

**SATURDAY 3 JUNE – MONDAY 5 JUNE, 2017**

© 2017, Geological Survey of Slovenia  
University of Ljubljana, Faculty of Civil and Geodetic Engineering  
University of Ljubljana, Faculty of Natural Sciences and Engineering

Editors: Mateja Jemec Auflič  
Matjaž Mikoš  
Timotej Verbovšek

Organisation of Post Forum  
Study Tour: Mateja Jemec Auflič, Jernej Jež, Timotej Verbovšek, Tomislav Popit,  
Matej Maček, Matjaž Mikoš, Anica Petkovšek, Janko Logar

Technical editor: Mateja Jemec Auflič and Staška Čertalič

Graphic Design: Staška Čertalič

Published by: University of Ljubljana, Faculty of Civil and Geodetic Engineering  
For the Publisher: Prof. Dr. Matjaž Mikoš

Printed by: Tiskarna Oman Peter Oman s.p.  
Copies: 70

Publication was supported by: Geological Survey of Slovenia  
University of Ljubljana, Faculty of Civil and Geodetic Engineering  
University of Ljubljana, Faculty of Natural Sciences and Engineering  
Slovenian Geological Society

Authors take responsibility for their  
contributions.

The publication is free of charge.

Front Cover Photo by Mihael Ribičič  
(Extensive remediation works after  
Stože landslide triggered in November  
2000)

CIP- Kataložni zapis o publikaciji  
Narodna in univerzitetna knjižnica, Ljubljana  
550.348.435(497.4)(082)

LIVING with slope mass movements in Slovenia and its surroundings :  
post forum study tour guide book, Saturday 3 June- Monday 5 June, 2017  
/ [editors Mateja Jemec Auflič, Matjaž Mikoš, Timotej Verbovšek]. - Ljubljana :  
Faculty of Civil Engineering and Geodetic Engineering, 2017  
ISBN 978-961-6884-47-1  
1. Jemec Auflič, Mateja  
290342400

POST FORUM STUDY TOUR GUIDE BOOK

**LIVING WITH SLOPE MASS MOVEMENTS IN  
SLOVENIA AND ITS SURROUNDINGS**

SATURDAY 3 JUNE – MONDAY 5 JUNE, 2017

## WLF4 POST FORUM STUDY TOUR SCHEDULE

1 <sup>st</sup> day, Saturday 3 June 2017 (Ljubljana – Vipava Valley – Kobarid)	
07:30 – 09:10	Departure from Ljubljana (Erjavčeva street, in front of Cankarjev dom)
09:10 – 10:00	<i>Field stop 1A:</i> Geological introduction to slope mass movements in the Vipava Valley
10:00 – 11:00	<i>Field stop 1B:</i> Construction of retaining structures at Motorway H4 Razdrto–Vipava
11:00 – 12:20	<i>Field stop 1C:</i> View of landslides in Rebrnice area
12:45 – 14:00	Lunch
14:30 – 15:30	<i>Field stop 2:</i> Visit to the Stogovce landslide
15:30 – 17:30	<i>Field stop 3:</i> Visit to the Slano Blato landslide
17:30 – 19:00	Bus transfer from Vipava Valley to Kobarid, view of <i>the</i> fossil landslide Selo from the bus ( <i>field stop 4</i> )
19:00 – 19:30	Hotel accommodation
19:30 – 21:30	Dinner in the hotel
2 <sup>nd</sup> day, Sunday 4 June 2017 (Kobarid – Bovec)	
07:00 – 08:00	Breakfast
08:00 – 09:30	Tour of the Kobarid museum and Charnel House
09:30 – 10:00	Departure from Kobarid and bus transfer to the Koseč village
10:00 – 12:00	<i>Field stop 5:</i> Visit to the Strug landslide
12:00 – 13:00	Bus transfer from Koseč to Bovec
13:00 – 14:30	Lunch
14:30 – 15:00	Bus transfer to village of Log pod Mangartom
15:00 – 18:30	<i>Field stop 6:</i> Visit to the Stože landslide
18:30 – 19:00	Bus transfer to Bovec
19:00 – 19:30	Hotel accommodation
19:30 – 21:30	Dinner in the hotel
3 <sup>rd</sup> day, Monday 5 June 2017 (Bovec – Malborghetto (IT) – Dobratsch (AT) – Kranjska Gora (SI)– Ljubljana)	
07:00 – 08:00	Breakfast
08:00 – 09:00	Departure from Bovec and bus transfer to Malborghetto–Valbruna (Italy)
09:00 – 11:30	<i>Field stop 7:</i> Visit to the Malborghetto–Valbruna (Italy) debris flow events
11:30 – 12:30	Bust transfer from Malborghetto–Valbruna to Arnoldstein (Austria)
12:30 – 14:00	<i>Field stop 8:</i> View of the Dobratsch massif
14:00 – 15:00	Bus transfer from Arnoldstein to Kranjska Gora (Slovenia)
15:00 – 16:00	Lunch
16:00 – 16:45	Bus transfer to Blejska Dobrava
16:45 – 17:30	<i>Field stop 9:</i> View of Potoška planina landslide
17:30 – 18:20	Bus transfer to Ljubljana (arrival at the Congress Centre Cankarjev Dom)

### CONTACT INFORMATION

Dr. Mateja Jemec Auflič, Ljubljana, Slovenia  
 Geological Survey of Slovenia  
 Email: mateja.jemec@geo-zs.si; Phone: 00386 1 2809815; Mobile: 00386 31 717099

Assoc. Prof. Dr. Timotej Verbovšek  
 University of Ljubljana, Faculty of Natural Sciences and Engineering, Ljubljana, Slovenia  
 Email: timotej.verbovsek@geo.ntf.uni-lj.si; Phone: 00386 1 4704644

Prof. Dr. Matjaž Mikoš  
 University of Ljubljana, Faculty of Civil and Geodetic Engineering, Slovenia  
 Email: matjaz.mikos@fgg.uni-lj.si; Phone: 00386 1 4768509; Mobile: 00386 41 761186

# TABLE OF CONTENTS

<b>INTRODUCTION</b> .....	7
<b>SLOPE MASS MOVEMENTS IN THE VIPAVA RIVER VALLEY (1<sup>ST</sup> DAY)</b>	
1. REBRNICE LANDSLIDES .....	9
Authors: Jernej Jež, Tomislav Popit, Matej Maček	
2. STOGOVCE LANDSLIDE .....	12
Authors: Matej Maček, Timotej Verbovšek	
3. SLANO BLATO LANDSLIDE .....	15
Authors: Matej Maček, Timotej Verbovšek, Igor Benko	
4. SELO LANDSLIDE .....	21
Authors: Tomislav Popit, Timotej Verbovšek	
<b>THE SOČA RIVER VALLEY (2<sup>ND</sup> DAY)</b>	
5. STRUG LANDSLIDE .....	23
Authors: Matjaž Mikoš, Mihael Ribičič	
6. STOŽE LANDSLIDE .....	26
Authors: Matjaž Mikoš, Mihael Ribičič, Anica Petkovšek	
<b>NW SLOVENIA, ITALY AND AUSTRIA (3<sup>RD</sup> DAY)</b>	
7. VALCANALE VALLEY, MALBORGHETTO - VALBRUNA DEBRIS FLOW EVENTS (ITALY) .....	31
Authors: Chiara Calligaris, Chiara Boccali, Luca Zini	
8. DOBRATSCH ROCKSLIDES (AUSTRIA) .....	36
Author: Jürgen M. Reitner	
9. POTOŠKA PLANINA LANDSLIDE .....	43
Author: Tina Peternel, Jošt Sodnik	
<b>REFERENCES</b> .....	47

## INTRODUCTION

The Post-Forum Study Tour following the 4<sup>th</sup> World Landslide Forum 2017 in Ljubljana (Slovenia) focuses on the variety of landslide forms in Slovenia and its immediate NW surroundings, and the best-known examples of devastating landslides induced by rainfall or earthquakes. The route of Post Forum Study Tour and landslide locations in Slovenia and NW surroundings can be seen in Fig. 1.

Landslides differ in complexity of the both surrounding area and of the particular geological, structural and geotechnical features. Many of the landslides of the Study Tour are characterized by huge volumes and high velocity at the time of activation or development in the debris flow. In addition, to the damage to buildings and infrastructure, the lives of hundreds of people are also endangered; human casualties occur.

On the first day, we will observe complex Pleistocene to recent landslides related to the Mesozoic carbonates thrust over folded and tectonically fractured Tertiary siliciclastic flysch in the Vipava Valley (SW Slovenia), serving as the main passage between the Friulian lowland and central Slovenia, and thus also an important corridor connecting Northern Italy to Central Europe. A combination of unfavorable geological conditions and intense short or prolonged rainfall periods leads to the formation of different types of complex landslides, from large-scale deep-seated rotational and translational slides to shallow landslides, slumps and sediment gravity flows in the form of debris or mudflows.

The second day of the study tour will be held in the Soča River Valley located in NW Slovenia close to the border with Italy, where the most catastrophic landslide in Slovenia recently, the Stože landslide, caused the deaths of seven people, and the nearby Strug landslide, which is a combination of rockfall, landslide, and debris flow.

The final day of the Post-Forum Study Tour will start in the Valcanale Valley located across the border between Slovenia and Italy, severely affected by a debris flow in August 2003. The flow caused the deaths of two people, damaged 260 buildings; large amounts of deposits blocked the A23 Highway, covering both lanes. In Carinthia (Austria), about 25 km west of Villach, the Dobratsch multiple scarps of prehistoric and historic rockslides will be observed. Dobratsch is a massive mountain ridge with a length of 17 km and a width of 6 km, characterized by steep rocky walls. The three-day study tour will conclude with a presentation of the Potoška planina landslide, a slide whose lower part may eventually generate a debris flow and therefore represents a hazard for the inhabitants and for the infrastructure within or near the village of Koroška Bela.

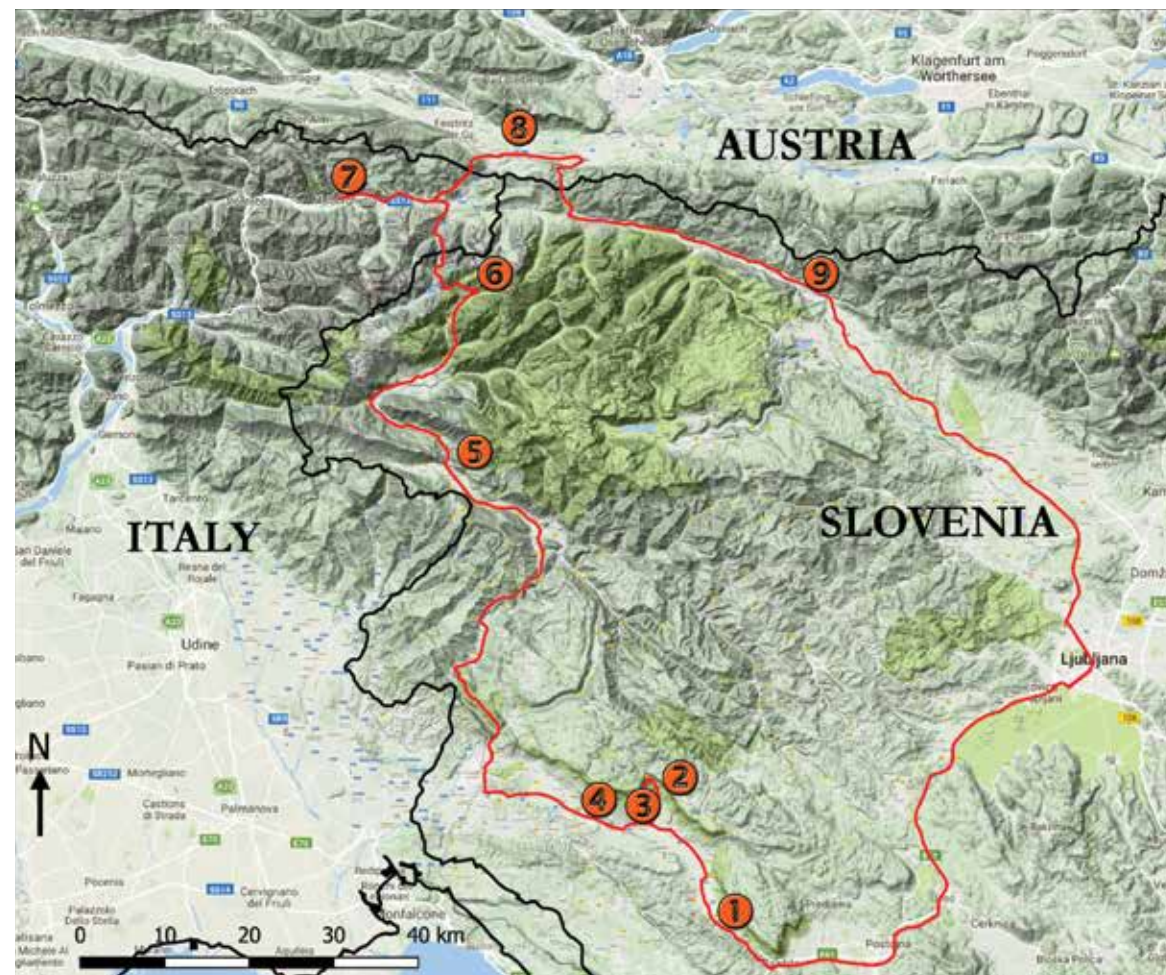

Fig. 1: The route of the Post Forum Study Tour. Landslide locations in Slovenia and NW surroundings are marked by numbers from 1 to 9. Numbers correspond to the landslide descriptions that follow below.

## SLOPE MASS MOVEMENTS IN THE VIPAVA RIVER VALLEY (1<sup>ST</sup> DAY)

In the Vipava River Valley, in SW Slovenia, complex Pleistocene to recent landslides are related to the Mesozoic carbonates thrust over folded and tectonically fractured Tertiary siliciclastic flysch (Fig. 2). Such overthrusting has caused steep slopes and fracturing of the rocks, producing intensely weathered carbonates and large amounts of scree deposits. Elevation differences here are significant and range from 100 m at the valley bottom to over 1200 m on the high karstic plateau. The combination of unfavorable geological conditions and periods of intense short or prolonged rainfall (average precipitation is approximately 1700 mm to 2500 mm/year on the karstic plateau) has led to the formation of different types of complex landslides. Recently, carbonates have been breaking down in the form of steep fans of carbonate scree in the upper part of the valley, increasing the thickness of these sediment layers to well over 10 m. In the lower part, superficial deposits range from large-scale, deep-seated rotational and translational slides to shallow landslides, slumps, and sedimentary gravity flows in the form of debris or mudflows reworking the carbonate scree and flysch material.

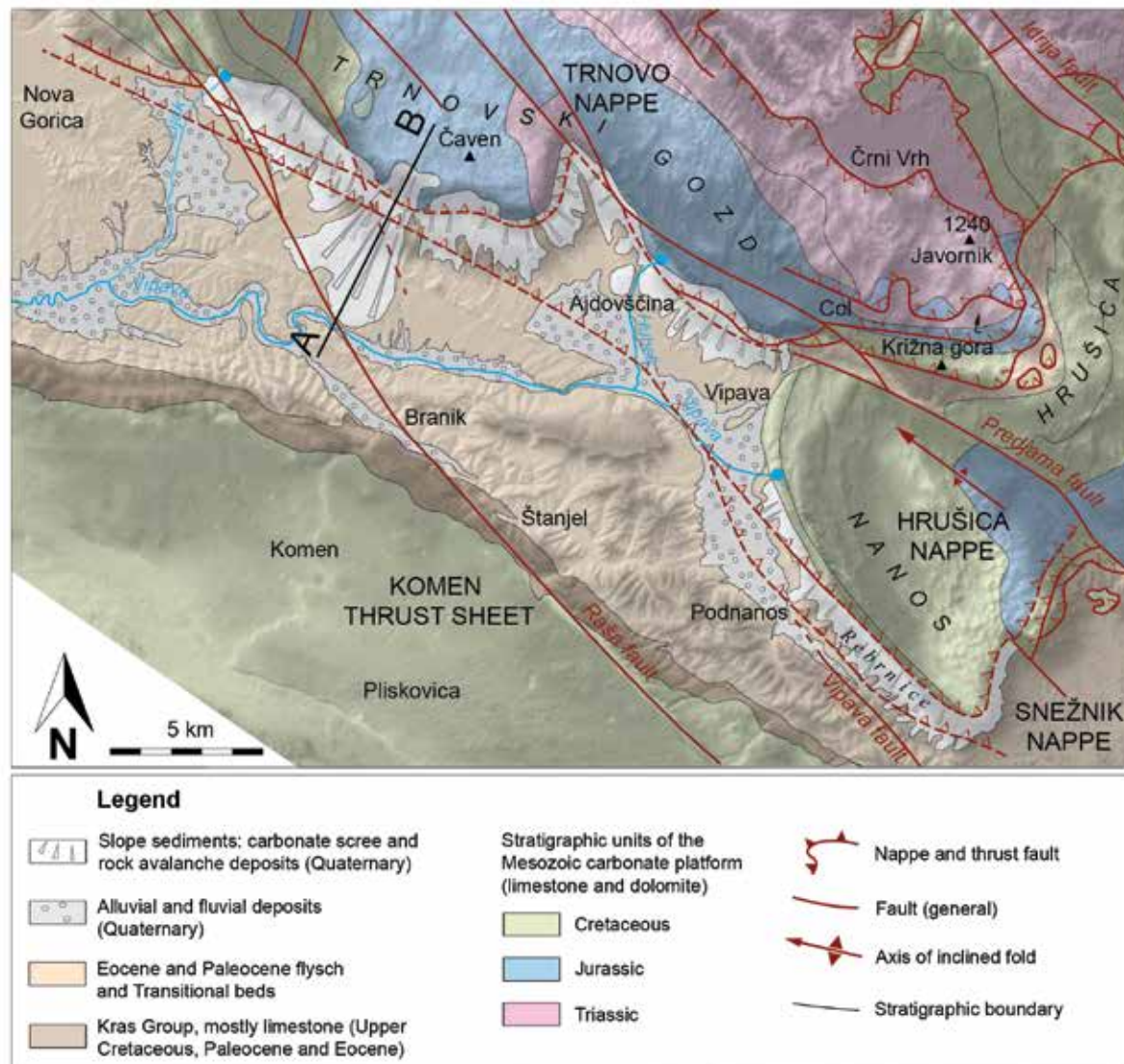

Fig. 2: Geological map of the Vipava valley (Popit, 2016).

## 1. REBRNICE LANDSLIDES

Authors: Jernej Jež, Tomislav Popit, Matej Maček

The Rebrnice area is a SW-facing slope that borders the Vipava Valley and the NE-lying Nanos Plateau in SW Slovenia. The area is geotectonically part of a complex SW-verging fold-and-thrust structure of the External Dinarides composed of a series of nappes of Mesozoic carbonates thrust over Palaeogene flysch (Placer, 1981) (Fig. 2). This geotectonic position is reflected in the distinct asymmetric aspect of the valley slopes, where the upper part of the slope is marked by steep carbonate cliffs, while the middle and lower areas are more gently sloped and composed of flysch bedrock covered by numerous fan- and tongue-shaped Quaternary superficial deposits (Jež, 2007; Popit et al., 2014; Popit, 2016; Popit et al., 2016; Popit et al., 2017). The superficial deposit of the fossil landslides covers an area of more than 2,8 million km<sup>3</sup> and reaches a maximum thickness of 50 m. The sedimentary texture and structure of the complex fossil landslides in the Rebrnice area clearly indicate multiple depositional events and various gravitational mass movement processes, ranging from slides to flows (Popit et al. 2013; Popit et al., 2016) (Fig. 3). Accelerator mass spectrometry (AMS) radiocarbon dating of charred wood extracted from the Šumljak fossil landslide in the Rebrnice area (around 45 thousand years) indicates a considerable range in the age of superficial deposit, which reaches back to at least as far as the last glacial cycle (Marine isotope stages 3) (Popit et al., 2013). The interdependence among the fossil slope sediments distribution and recent landslide reactivations is the essential for today's hazard.

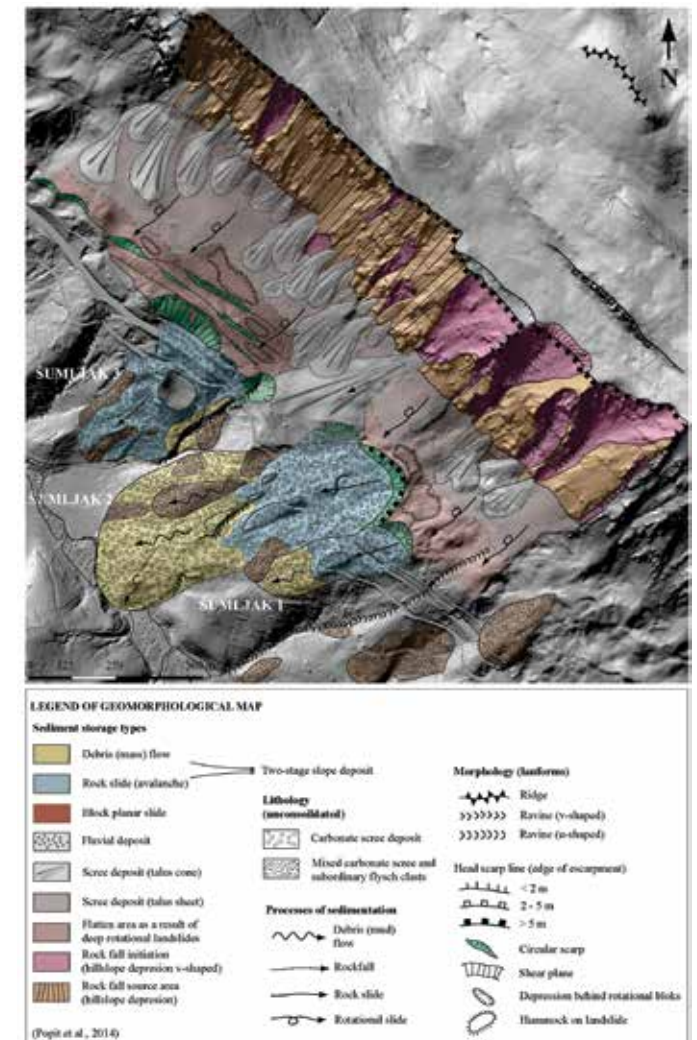

Fig. 3: A geomorphological map of the Šumljak sedimentary bodies and their hinterland in the Rebrnice area (Popit, 2016).

One of the main reasons for embarking on detailed geological and geo-mechanical research of superficial deposit was the construction of the motorway across this area. About 10 km of motorway H4 Razdrto-Vipava is crossing Rebrnice. This road represents an important connection between central Slovenia and northern Italy. Technically, the construction was very demanding. The route was chosen to minimize landslide areas and to retain water sores for the villages in the Vipava river valley. The construction of this section started in 2003 and was finished in 2009. During construction some landslide activation occurred. The largest of them was SOR (Lozice) with about 600,000 m<sup>3</sup>. Due to difficulty of this motorway section a large number of objects were built to cross ravines and to retain slope stabilities, namely: 2 tunnels (ca 295 and ca 600 m), 2 cut and cover tunnels (ca 115 and ca 305 m), 8 viaducts (together 2570 m), 25 retaining structures (14 pile walls with length of 1334 m, 7 reinforced concrete walls with length 694 m and 3 shafts (with additional 7 in pile wall) (Fig. 4). Strong supporting structures were required to maintain both temporary and long-term stability of the landslides across vast sedimentary bodies.

In the case of the Boršt viaduct a foundation is made 13–22 m deep with a smaller viaduct column in a center, which enables movements of the upper less stable mass together while there are no earth pressures acting on a viaduct pillar (Fig. 5). Strong supporting structures (Fig. 6) were needed to maintain the temporary stability of slopes (Petkovšek et al., 2013). Nevertheless, many slope stability issues are still active concerns; and they indicate the need for remediation in some road sections. Recently, we have been monitoring some very extensive reactivated landslides. A thick cover of Quaternary superficial deposit (carbonate scree deposit) and breccia, tectonic deformations in the flysch, the presence of groundwater and the specific geomorphological setting represent highly significant technical challenges for the management of landslides.

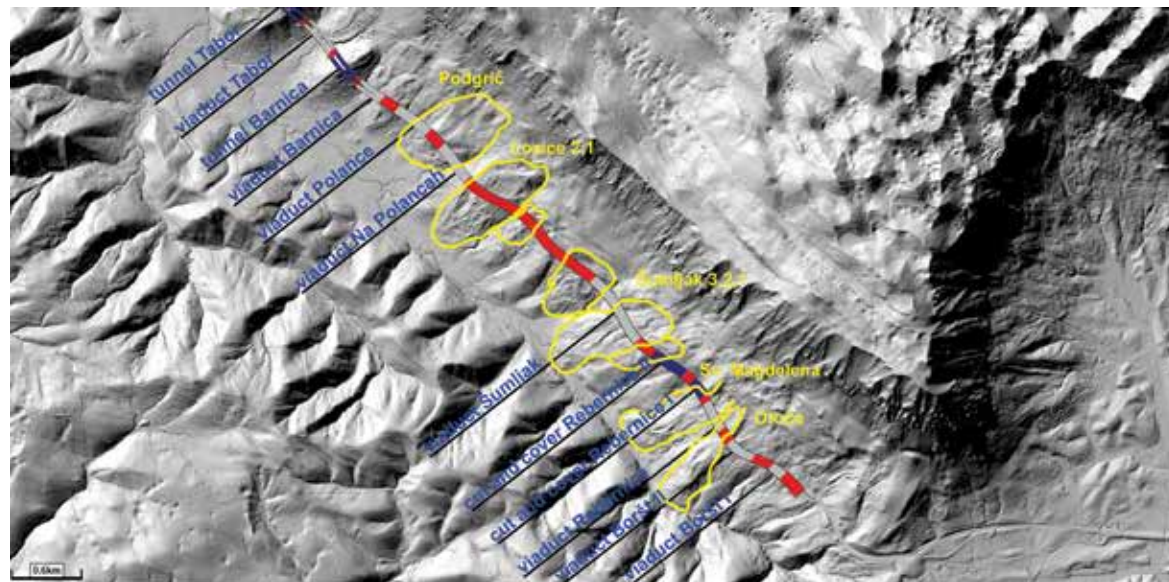

Fig. 4: Motorway H4 Razdrto-Vipava at Rebrnice with marked objects. Location of landslides (sedimentary bodies) are taken from Popit (2016).

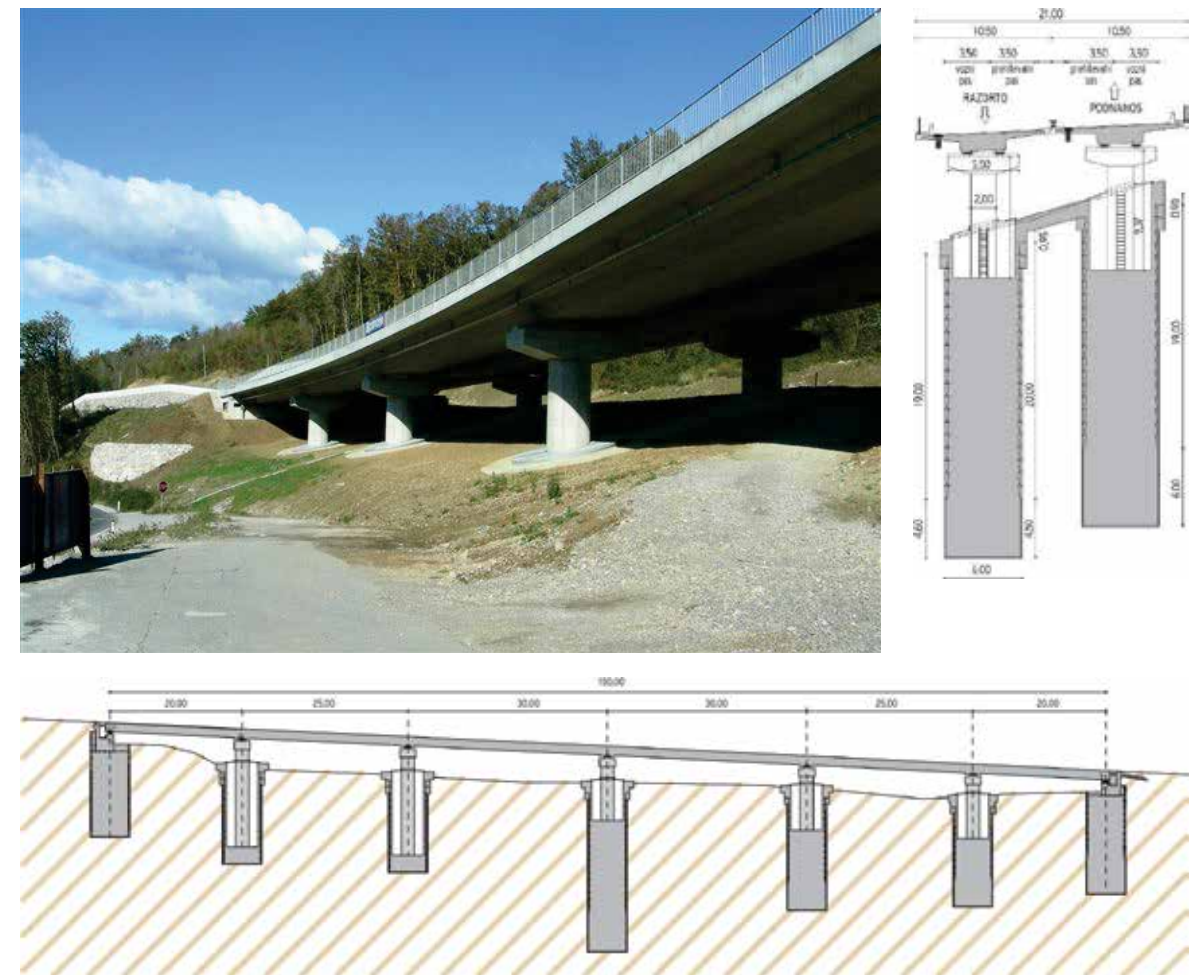

Fig. 5: Viaduct Boršt I (<http://www.fg.uni-mb.si/nanos/fotogalerija.htm>) with the cross-section trough central shaft and the longitudinal cross section. The hollow shafts enable movements of landslide without any force acting on bridge pillars.



Fig. 6: A- Construction of cut and cover tunnel Rebrnice I. B- Shafts used as a retaining structure near SOR (Lozice) landslide.



## 2. STOGOVCE LANDSLIDE

Authors: Matej Maček, Timotej Verbovšek

The Stogovce landslide is located ca. 200 m below the carbonate overthrust front atop Eocene flysch (Petkovšek et al. 2011, Jež et al., 2011). In this area, the flysch bedrock is covered by weathered flysch and carbonate scree cover some 6–28 m thick. The scree is sometimes consolidated into carbonate breccia. Individual larger carbonate blocks some cubic meters in size are also present in the sediments (Verbovšek et al., 2017a). The landslide zone was active even before the triggering of the landslide of 2010. These developments were observed since 2000 on a local road as cracks and smaller slides, with the road in constant need of maintenance (Petkovšek et al., 2011). No monitoring of movements was applied at that time. The Stogovce landslide was triggered by an extreme precipitation event on 18 September 2010 as two small rotation slips. On September 19 about 0.5 m high scarps appeared on the road and towards the evening, the rate of displacements increased significantly, and the road moved for 5 to 8 m (Fig. 7).



Fig. 7: Landslide Stogovce A, B- a view towards north on the destroyed road; C- The view of Stogovce landslide, view towards south; D- The main scarp. Carbonate breccia overlies carbonate scree.

In the following weeks, the slopes bordering the initial landslides were triggered until the landslide grew to 700 m wide and 200–300 m long (Fig. 8). Approximately one million m<sup>3</sup> of carbonate rock debris and weathered flysch moved towards the Lokavšček torrent (Petkovšek et al., 2011). About 300 m of the creek bed were covered by more than a 10 m thick layer of landslide material. The water flowed at the toe of the landslide and was not dammed the stream. During this event, a one-kilometer-long section of local road leading to local villages was destroyed, together with the power supply station that ran the water pumping station. It was also found that about 300,000 m<sup>3</sup> of material from the Stogovce landslide could generate debris flow if the landslide dammed the Lokavšček stream, which

would pose a risk to nearby villages. Several vital structural remediation works and measures were undertaken, such as a new road, a power supply station, and a small dam at the Lokavšček stream to provide dewatering of the potential natural dam.

Monitoring of the landslide is performed using GNSS probes (Fig. 9) and inclinometers and indicates movement in the range of 1–5 cm/year, with maximum values up to 3 cm/month (Verbovšek et al., 2017a). The GNSS probes also act as an early warning system when monitored movements exceed 10 cm per day.



Fig. 8: Interpretation of Stogovce landslide, older fossil landslide in the upper part and more recent activation in the lower part.



Fig. 9: A- installed GEASENSE probe; B- Locations of GEASENSE probes (Verbovšek et al., 2017a).

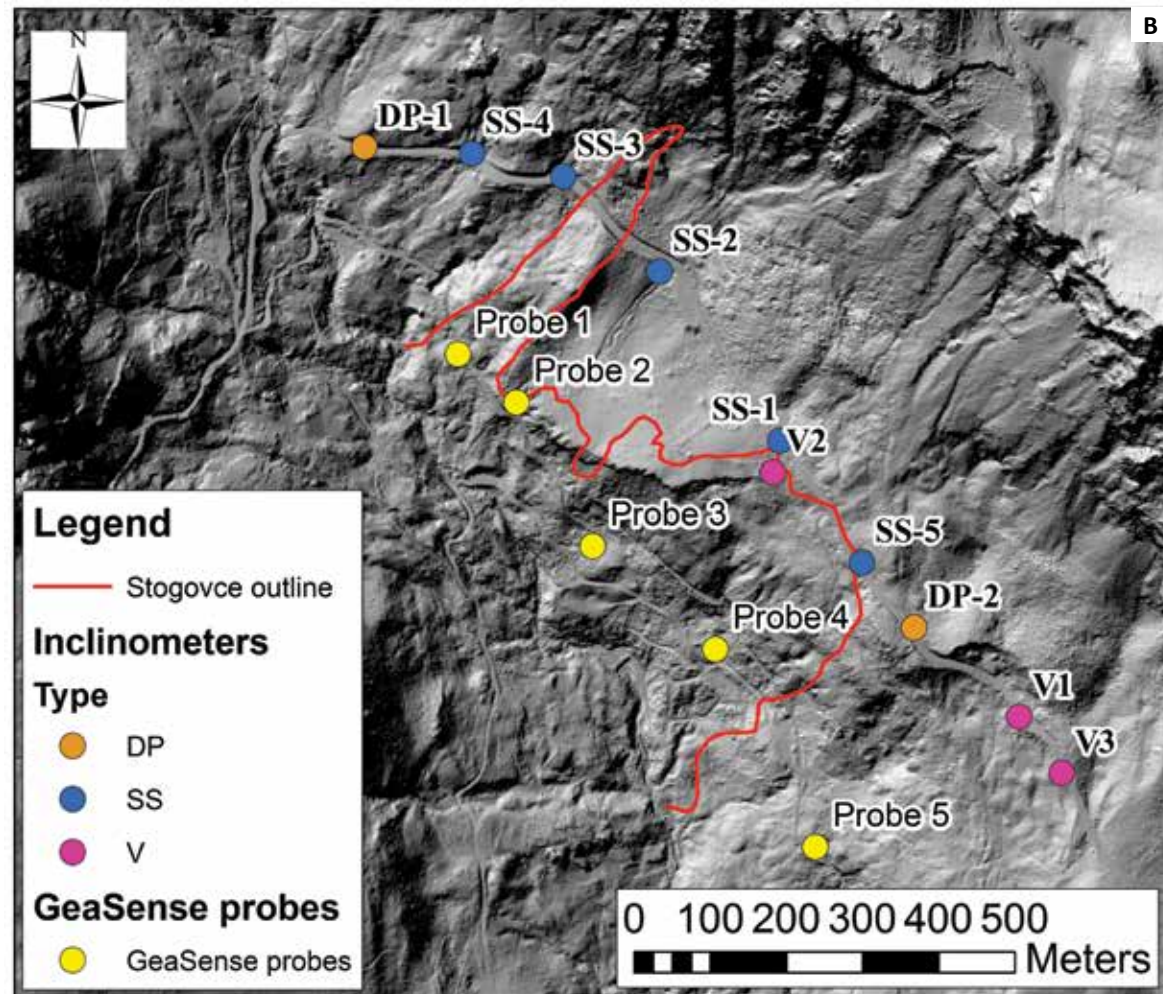

### 3. SLANO BLATO LANDSLIDE

Authors: Matej Maček, Timotej Verbovšek, Igor Benko

The Slano blato landslide is located above the village of Lokavec in the Vipava River Valley. This landslide differs from other landslides in the Vipava Valley by a mud-dominated composition of the transported material and the occurrence of salt efflorescences (predominantly sodium sulphate of the thenardite-mirabilite system) on the landslide surface (Martín-Pérez et al., 2016), hence the name Slano Blato, meaning 'salty mud'. The salt efflorescences are a result of dissolution of sulfates and sulfides which were found together with organic content on discontinuous inside the flysch rock (Fig. 10) (Petkovšek, 2006).

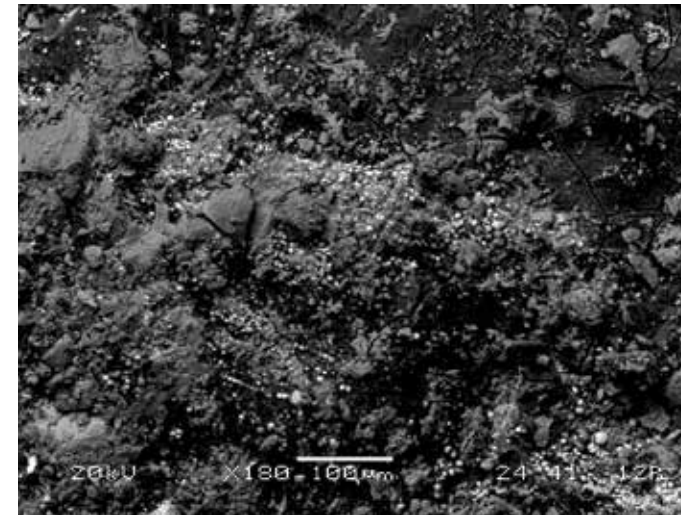

Fig. 10: Deteriorated flysch surface covered with pyrite. Micro cracks could also be visible (Petkovšek, 2006).

The main scarp is located near the carbonate overthrust atop Eocene flysch. In the more remote part of the landslide is a structural depression that renders the area relatively unstable, owing to the high underground water table it sustains (Placer et al., 2008). Historical sources reported events in 1786 and 1885 (Fig. 11), when landslides flooded the villages and the main road at the bottom of the valley. At the end of the 19th century, the first retaining measures were taken: small check dams (Fig. 12) were erected in order to retain the mud and reduce the slope angle. The stream bed was widened, and a construction ban in the influence area was put into effect (Logar et al., 2005). These structural measures had badly deteriorated or been completely neglected, and the landslide was retriggered some 100 years later, on 17–19 November 2000 during a period of heavy and long lasting rain. Since then, many researchers have investigated and monitored this landslide, largely in order to define displacement rates and the landslide's particular characteristics that later formed the basis of the mitigation and remediation measures (Majes et al., 2002; Ribičič and Kočevar, 2002; Logar et al., 2005; Placer et al., 2008; Fifer Bizjak and Zupančič, 2009; Mikoš et al., 2009; Maček et al., 2016; Martín-Pérez et al., 2016). The landslide started as a rotational slide at the altitude of ca. 570 m. Within a few days, it had grown to a length of 500 m, and to 60–250 m wide and 10 m deep (Fig. 13). The material moved consisted of clayish gravel in the upper area and weathered flysch in the lower area (Fig. 14) (Ribičič and Kočevar, 2002). Due to continuous rainfall at the time, together with the uneven landslide surface, lakes formed in the landslide area. The water wet the sliding mass and transformed it into a mudflow, with a downward maximum velocity of 60–100 m/day and coming to a halt at the altitude of 460 m (at 'Mud Lake'). Earthflow events repeated several times in the years that followed (2001–2004), and occasionally the material transformed into minor yet very rapid to extremely rapid mudflows. At the same time, the retrogressive rotational slide occurred above the main scarp, feeding the landslide with new unstable masses. The landslide is currently 1.4 km in length and boasts a volume of more than 1 million m<sup>3</sup>.



Fig. 11: The first source of the landslide in 1789 (Hacquet, 1789) and the old check dams from the beginning of the 20th century (Benko, 2011).



Fig. 12: About a 125 years old photography of Slano blato landslide (Dušan Hmeljak) and Slano blato in 2011 (Benko, 2011).

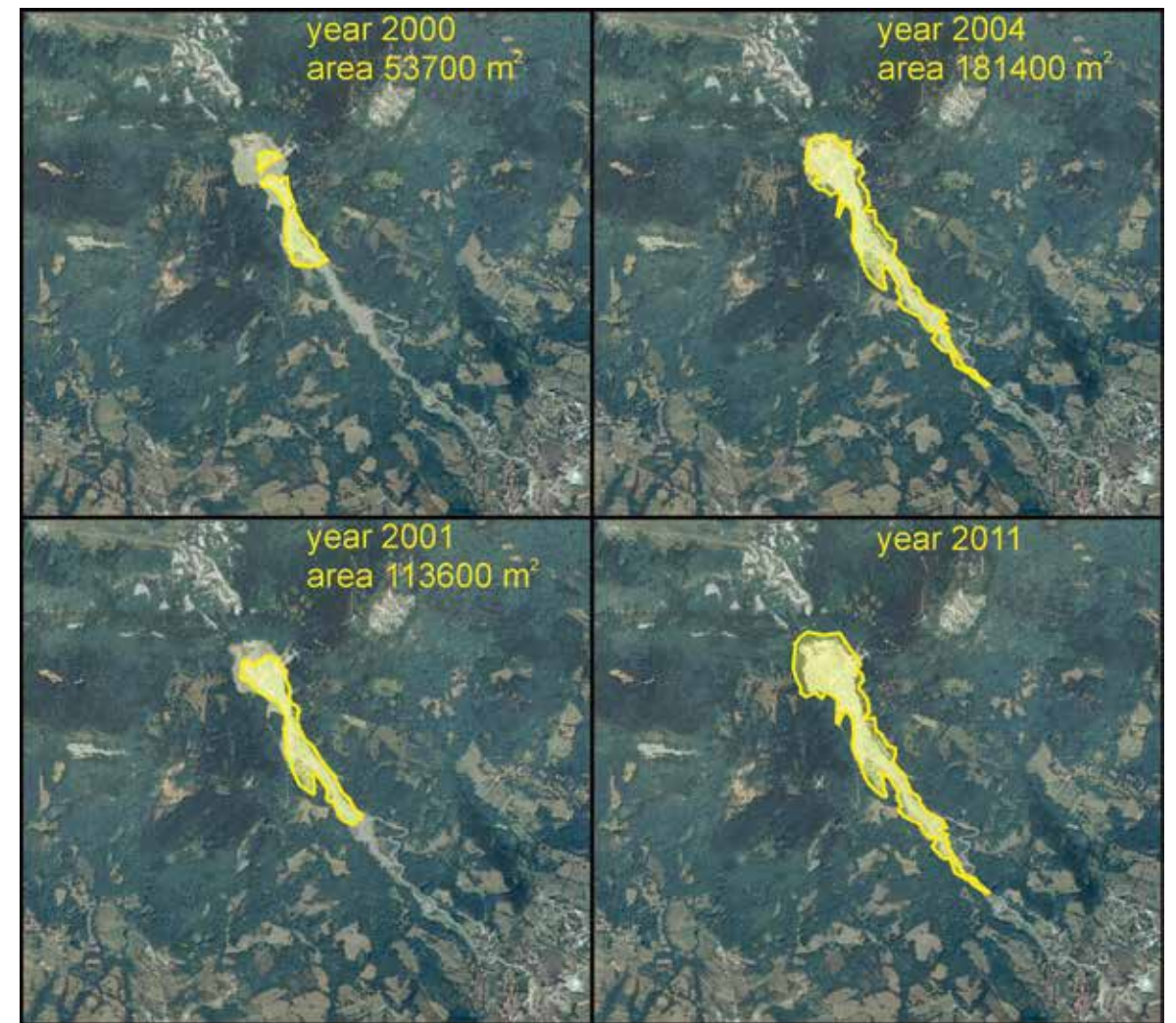

Fig. 13: Progressive widening of the Slano blato landslide (Petkovšek et al., 2013).

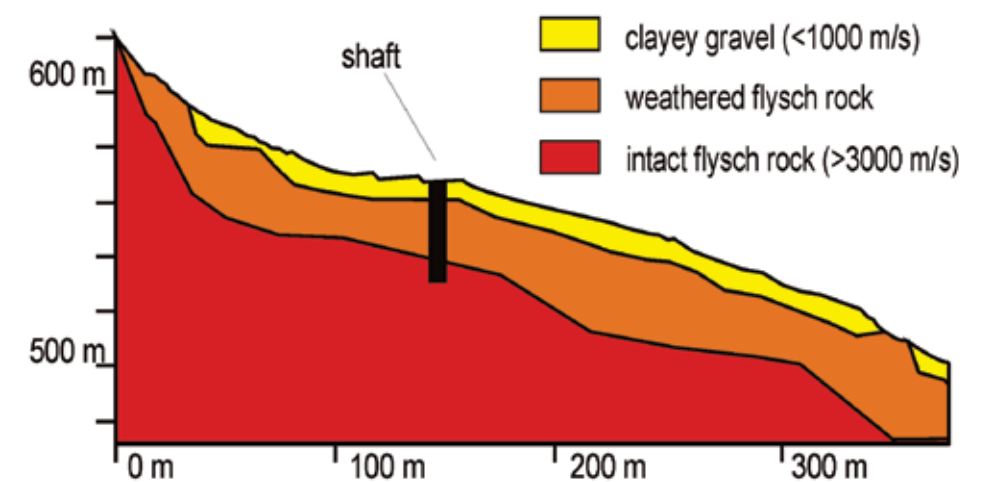

Fig. 14: Simplified geoseismic refraction profile with the shaft position (Petkovšek et al., 2013).



Fig. 15: Slano blato landslide in 2000 (upper part) and 2003 (lower part) (Petkovšek et al., 2010).



Fig. 16: Aerial view of the upper part of the Slano blato landslide with shafts and a small concrete dam (Pulko et al., 2014).

In order to protect the village from potential landslides, a small rockfill dam was constructed in 2002, with a retention volume of 5,000 m<sup>3</sup> and some 200,000 m<sup>3</sup> of material were removed from the landslide body. Between 2004 and 2007, several reinforced concrete shafts were constructed deep at the upper part of the landslide designed to stop its progressive widening. These shafts measure 8 m in diameter and run 24 m in depth, and serve both as a dewatering measure and as a retaining structure (Fig. 16; Fig. 17) (Pulko et al., 2014). In addition to the shafts, a 2 m high concrete dam was constructed to reduce the slope inclination below the dowels, the surface underwent a reshaping procedure, and a surface dewatering system was constructed (Fig. 18). Another 13 m high concrete dam is in construction to reduce erosion processes at 'Slap' (waterfall) location and prevent destabilization of the landslide body in the lower part of the Slano blato landslide. As a result of these retaining measures, the landslide is active only at the main scarp.

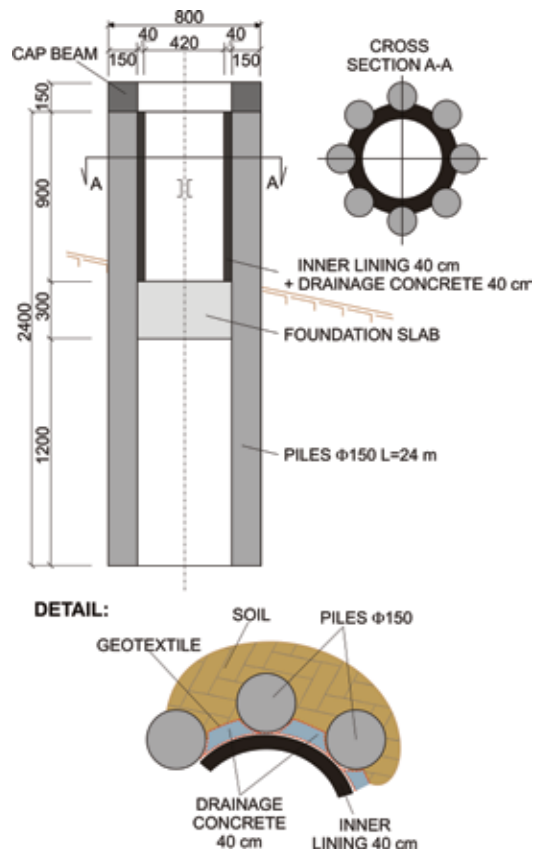

Fig. 17: Spatial scheme with vertical and horizontal cross-section of the modified design (left) (Pulko et al., 2014) and the placing of drainage concrete (top right) and the view on construction site in 2005 (lower right) (photo Geoinvest).



Fig. 18: Upper part of the Slano blato landslide above shafts in 2011.

#### 4. SELO LANDSLIDE

Authors: Tomislav Popit, Timotej Vrbošek

The Selo Landslide is a large landslide from Pleistocene composed predominantly of coarse carbonate material and characterized by its exceptional size and considerable runout length (Fig. 19) (Verbošek et al., 2017b, Košir and Popit, 2017). Landslide extent area of the carbonate debris is 4.5 km<sup>2</sup>, covering an area of more than 10 km<sup>2</sup>, with an estimated volume of about 190 × 10<sup>6</sup> m<sup>3</sup>. The estimated material balance, sediment volume and geometry indicate that the main landslide deposit most likely corresponds to a large-scale collapse of the upper carbonate slope (escarpment) developed from rock avalanche. Parameters describing the geometric relationships of the Selo landslide (an apparent friction coefficient, defined as H/L ratio; Fahrböschung) and its estimated volume correlate with data for landslides of comparable size (e.g. Legros, 2002), including some examples of typical rock slides (avalanches). Radiocarbon dating of wood debris entrained by the Selo landslide and excavated from the underlying paleosol and basal layers of landslide deposits yielded radiocarbon-dead values, clearly indicating the pre-Holocene age of the landslide (Popit and Košir, 2003). To determine the volume and geometry of the landslide and its potential source area, we integrated geological mapping, ground penetrating radar (GPR) and GIS techniques (Fig. 20).

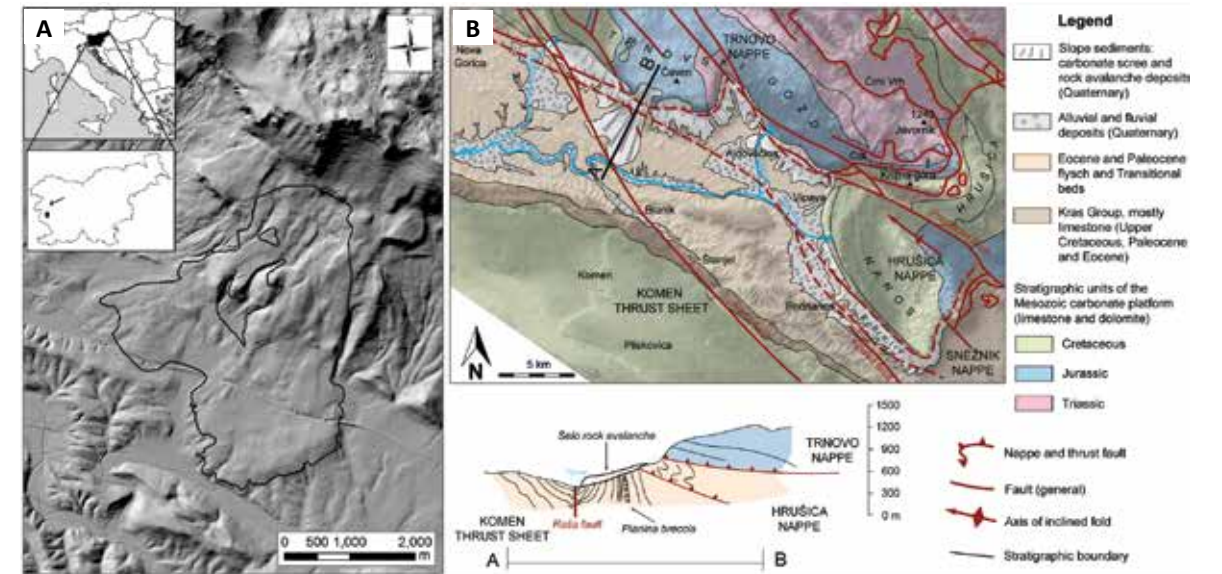

Fig. 19: A- Location and extent of the Selo landslide. B- Geological map of the broader area of SW Slovenia, with a cross section through the Selo landslide.

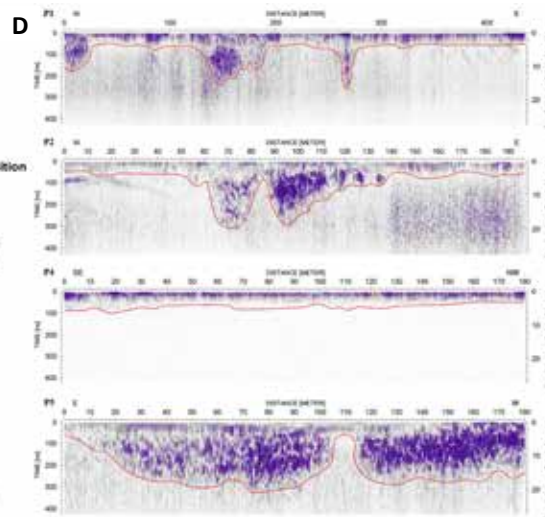
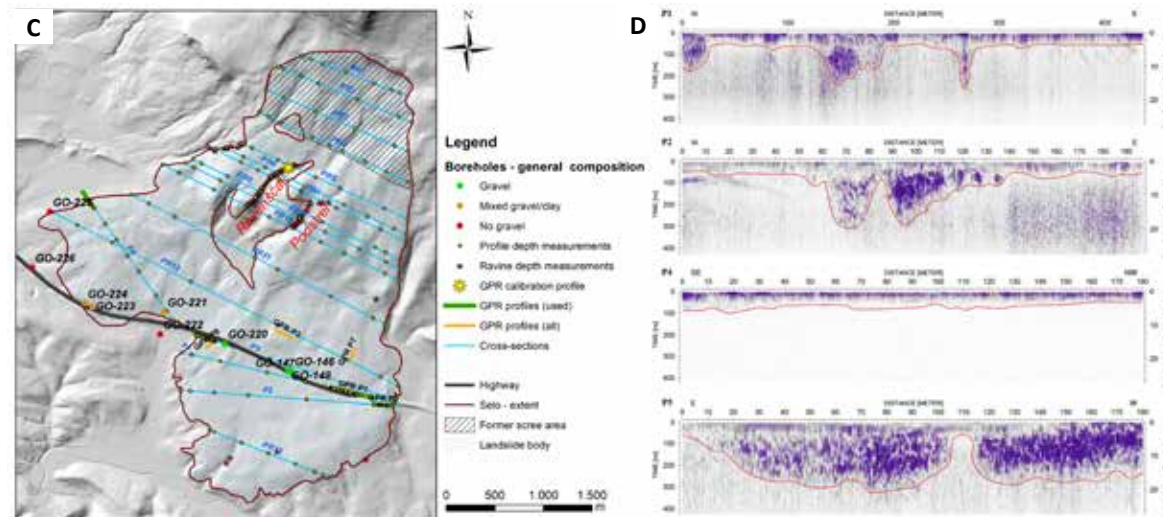

Fig. 20: A- Location of GPR1 profile. Cross section of the Selo landslide on the Vipava-Nova Gorica motorway construction site in 1999. GS indicates that clast-supported unit consists predominantly of limestone gravel with a subordinate amount of limestone cobbles and blocks; MS indicates that a mud-supported unit composed of pebbles, cobbles and several cubic metre blocks of limestone and sandstone, embedded in a muddy matrix. PS: palaeosol, FL: flysch composed of an alternation of siltstone, sandstone and marls. B- GS unit overlying the flysch in the Ravenščak ravine. C- Locations of the sediment thickness measurements in the ravines, GPR profiles, cross-sections, boreholes and extent of the Selo landslide. D- GPR profiles CP, P1, P2, P4 and P5 with boundary marked between the GS and MS units.

## THE SOČA RIVER VALLEY (2<sup>ND</sup> DAY)

### 5. STRUG LANDSLIDE

Authors: Matjaž Mikoš, Mihael Ribičič

The Strug landslide was initiated in a small watershed of the Brusnik Torrent in December 2001 (Fig. 21), above the village of Koseč in the Upper Soča River valley in NW Slovenia. The Strug landslide occurred at the contact point between highly-permeable calcareous rocks (Cretaceous scaglia) thrust over largely impermeable clastic rocks (Cretaceous flysch) – a complex landslide featuring a combination of various unstable materials (Mikoš et al., 2006b). The landslide was triggered by a single large rockslide that soon activated a rock fall, resulting (by virtue of its load) in a translational debris slide.

The understanding of the initiation mechanisms of the slope instabilities was important in order to be able to forecast future development. After the reambulation of all known geologic data for the area, a detailed engineering geologic map (Fig. 22), a longitudinal profile of the Strug landslide (Fig. 23) and a plan view of different instability processes (Fig. 24) was prepared on the basis of a detailed field engineering geologic mapping. In the investigated area, the following rock types were determined as is shown in Fig. 22.

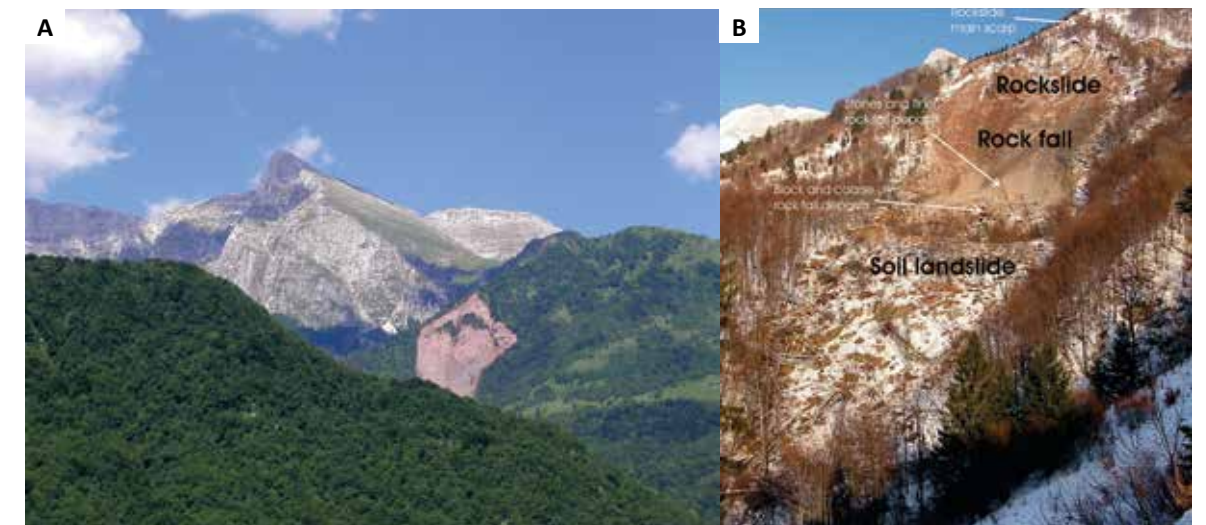

Fig. 21: The Strug landslide area. A- photo taken from nearby village; B- photo taken on 31 December, 2001.

In 2002, over 20 small debris flows (from 100 to ~1,000 m<sup>3</sup>) of gravels were initiated in the rock fall masses and started to flow from the rock fall source area over the landslide mass along the Brusnik Torrent channel towards the village of Koseč (Fig. 23). The monitoring system was immediately put in place for the inhabitants of Koseč, using field data from geotechnical (boreholes, inclinometers, groundwater levels) and hydro-meteorological networks (precipitation, weather station, occasional discharge measurements).

Observed data (velocity, debris-flow head height and estimated volumes of single surges) for debris flows flowing from the Strug source area, together with the estimated rock fall debris available for debris flow generation, were used to develop a numerical model for potential debris flows for a maximum estimated debris flow of 20,000 m<sup>3</sup>. The Brusnik channel was much enlarged and reformed into a parabolic cross-section with a constant longitudinal slope, and with mild curves (no sharp bends) (Fig. 25A). Furthermore, a new bridge with nearly twice the span of the old bridge was

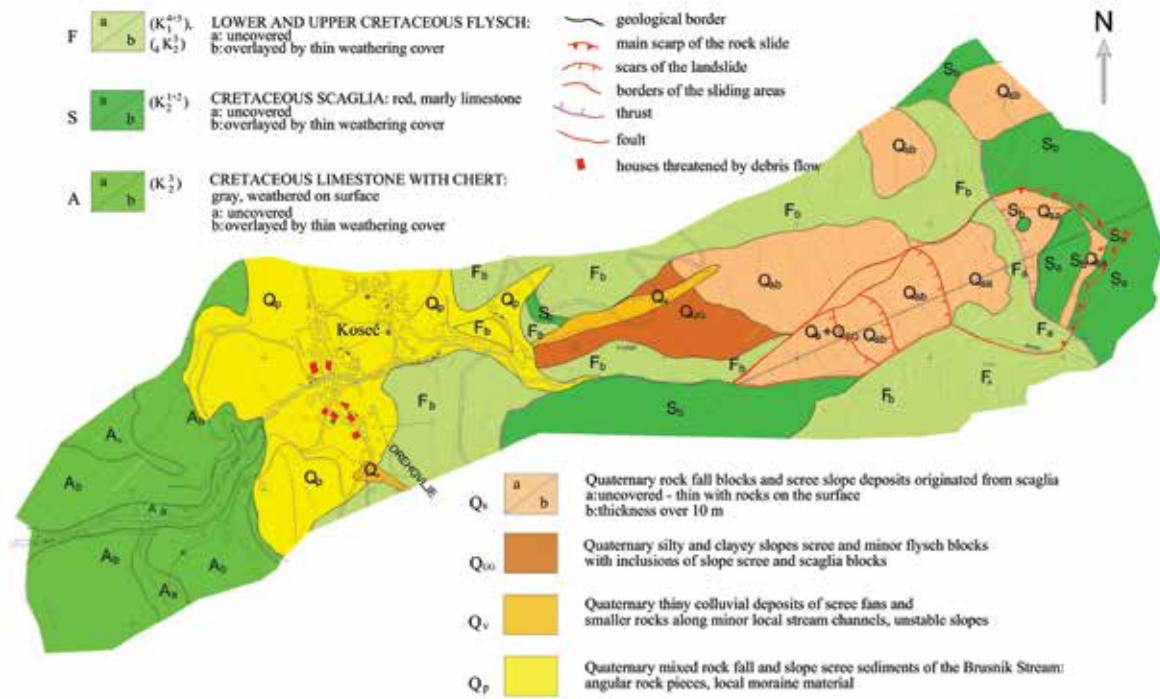

Fig. 22: Engineering geologic map of the Strug landslide (threatened houses in Koseč are given in red color).

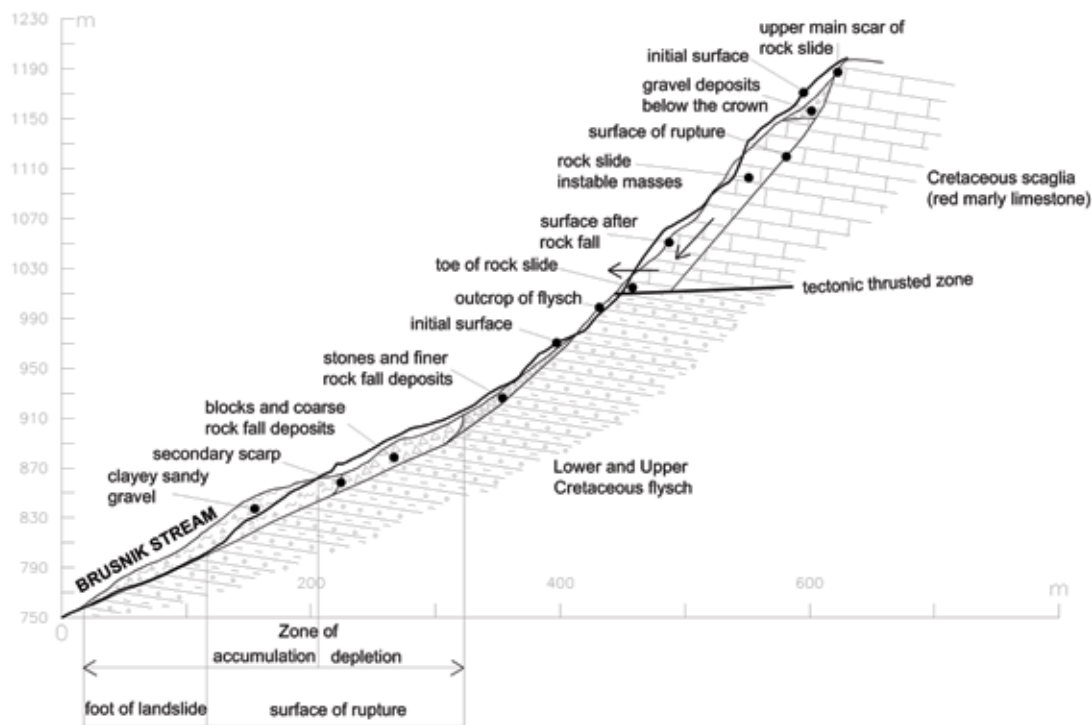

Fig. 23: The geological longitudinal profile of the Strug landslide with the rockslide and the soil landslide features (Mikoš et al., 2006a).

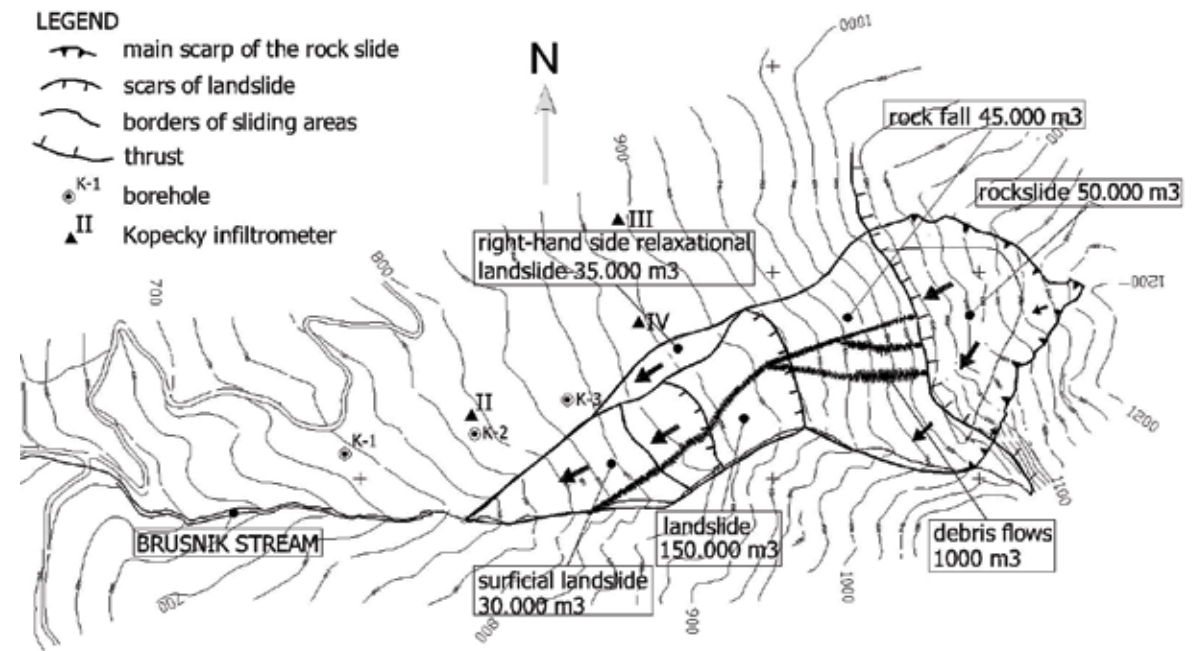

Fig. 24: A plan view of different slope instability processes in the Strug landslide area with measuring sites.



Fig. 25: Mitigation measures. A- Enlarged parabolic channel cross-section of largely constant longitudinal slope and no sharp curves; B- Implementation of a new bridge with nearly twice the span of the old bridge to connect the two parts of the village.

constructed that reconnected two parts of the Koseč village (Fig. 25B). Lastly, a sediment retention basin was constructed downstream of the Koseč village and another one upstream of the Ladra village, to protect the village from torrential hyper-concentrated flows. Subsequent regular field measurements after December 2001 revealed that the Strug landslide had moved into a far less active phase (Mikoš et al., 2005), and debris flows were no longer being initiated in the rock fall source area, as they were limited by the generation of much less fresh rock fall debris – even though local thunderstorms in the Brusnik watershed (less than 1 km<sup>2</sup>) brought with them enough water to generate considerable debris flow.

## 6. STOŽE LANDSLIDE

Authors: Matjaž Mikoš, Mihael Ribičič, Anica Petkovšek

The Stože landslide (Fig. 26A) which hit the village of Log pod Mangartom (Fig. 27) in western Slovenia minutes after midnight on 17 November 2000, was the largest single natural catastrophe to be recorded in the territory of Slovenia in the second half of the 20th century. The landslide event claimed seven lives and was the source of many discussions related to the possible cause(s) (local earthquake, heavy rainfall, and other influences) and immediate triggering factors, as well as the responsibility for its tragic consequences. The Stože landslide was triggered in the Koritnica River catchment, which covers an area of 87 km<sup>2</sup>. Permeable karst formations, glacial deposits, and alluvial formations are prevalent in this mountainous catchment; the only formation of low permeability in the region is located in the sub-catchment where the Stože landslide occurred (Mikoš et al., 2004).



Fig. 26: Stože landslide source area.

In two separate events, on 15 and 17 November 2000, near the Mangart Mountain (2,679 m a.s.l.), NW Slovenia, two translational landslides composed of morainic material (glacial till) filled with silt fraction (Fig. 27), with a total volume of more than 1.5 million m<sup>3</sup> occurred on the Stože slope. The first landslide was associated with a dry debris flow, and the second landslide with a wet debris flow. The rain-gauging station in the village of Log pod Mangartom recorded 1638.4 mm of rainfall (more than 60% of the average annual precipitation) in the 48 days, leading up to the events (rainfall intensity of 1.42 mm/h in 1152 h). The Stože landslide (two debris flow) was triggered by high artesian pressures built up in the slope after prolonged rainfall. The devastating dry and wet debris flows formed as the result of the Stože landslide masses undergoing significant infiltration of rainfall and surface runoff into the landslide masses and their subsequent liquefaction (Mikoš et al., 2004).

The geological settings was further investigated using field geophysical methods such as ground seismometry, ground radar, and through geological description of drilled cores from several structural boreholes in the landslide area and in the channel of the Mangart Creek (Fig. 28). In some boreholes, inclinometers were built in order to measure landslide movements.

Immediately after the catastrophic event, the whole landslide area was mapped in the field, created an engineering geological map of the Stože landslide area with main landslide features on the scale of 1:2,500 (Fig. 29). The Stože slope inclined from 20° to 30° in the NS direction and consisted of permeable cracked dolomite covered in its lower and middle part by unstable moraine sediments (low permeable silt with gravel that predominated in the debris flow) and in its upper part by high permeable scree deposits. The area west and east of the landslide consists of a dolomite formation.



Fig. 27: Aero view of the debris flow deposits in the settlement Log pod Mangartom after the devastating debris flow in November 2000 which claimed seven lives.

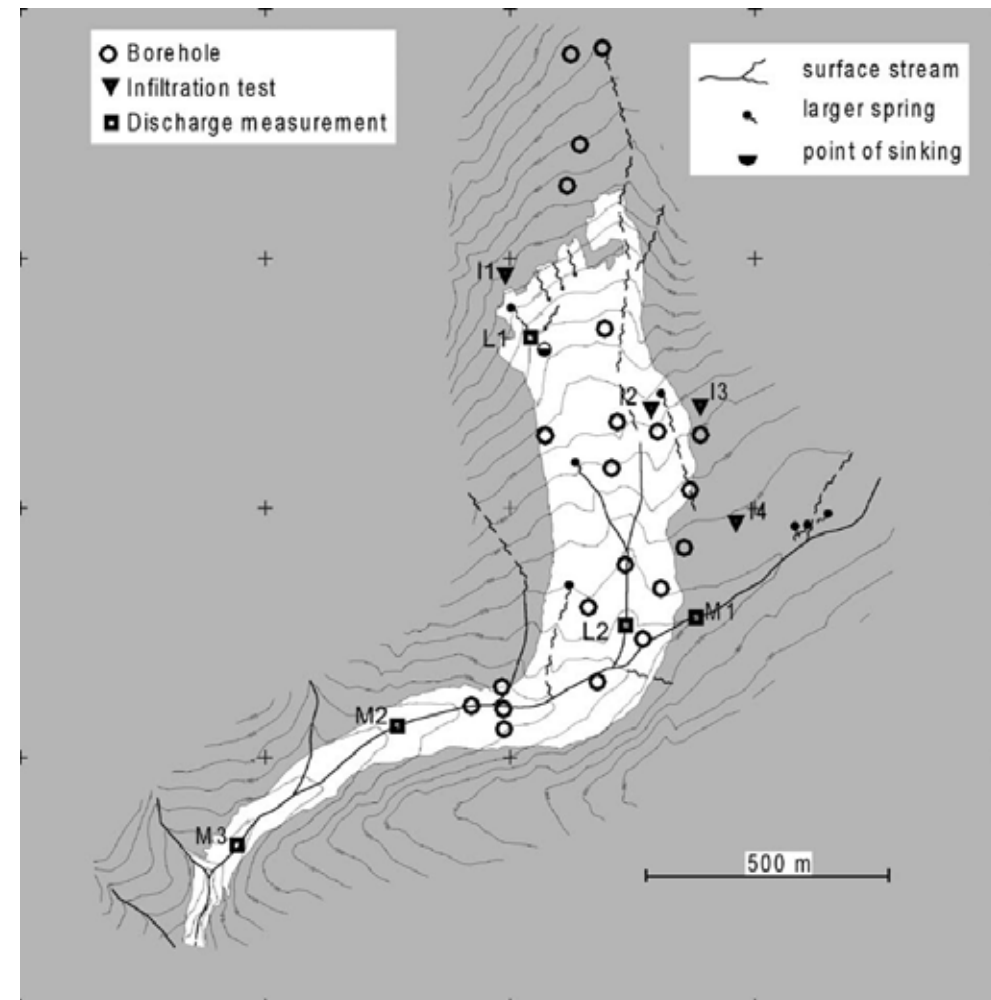

Fig. 28: A map showing structural boreholes drilled in the Stože landslide area and field sites for discharge and infiltration measurements (Mikoš et al., 2004).



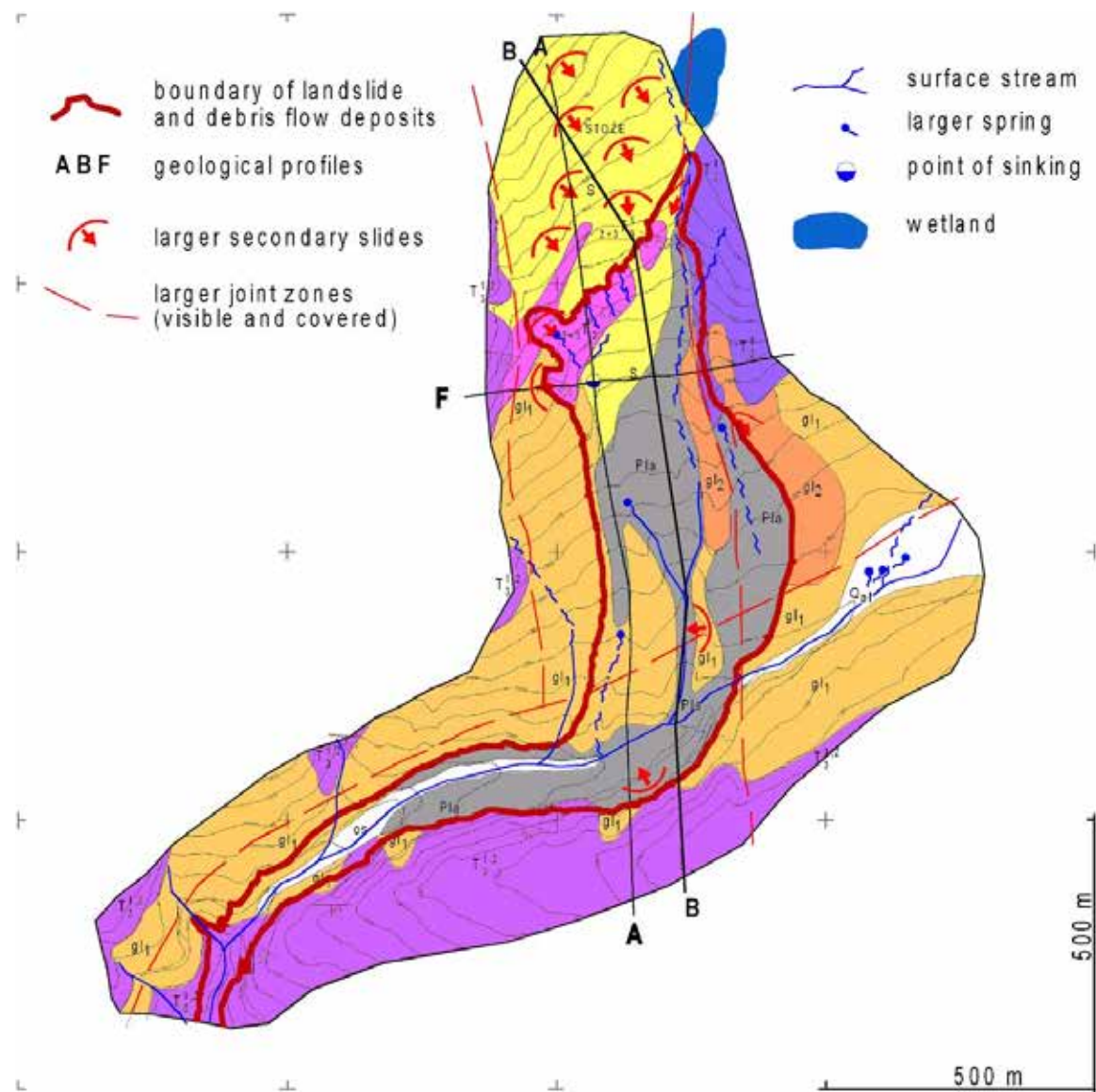

Fig. 29: The engineering geological map of the Stože landslide area, originally prepared on the scale of 1:2,500 (after Petkovšek, 2001). Legend: al—alluvium (poorly rounded gravel and debris; loose; porous; permeable); pla—deposited debris material after the debris flow on 17 November 2000 (mixed clayey, sandy and gravel material with some boulders; very loose; unstable; potential masses for new sliding); gl<sup>1</sup>—moraine of various consolidations (mainly silty– sandy– gravelly material; partially sorted; low permeability; stable at steep slopes); gl<sup>2</sup>—remnants of younger moraine or fossil landslide (clayey– silty soils with limestone gravels and larger boulders; low permeability; mainly from disintegrated marl); s—slope talus, coarse material (dolomite; loose; porous; unstable); T<sub>3</sub><sup>1,2</sup>—dolomite (layers thickness between 0.2 and 1 m with marl; massive; fractured along joints); <sub>2,3</sub>T<sub>3</sub><sup>1</sup>—dark grey limestone, marl limestone, marl and claystone (partially dolomitized, fractured and kneaded; weathering to layered debris with clay; of low permeability to unpermeable); T<sub>3</sub><sup>1</sup>—massive and stratified dolomite (solid core, on the surface brittle, along the joints millonitized, very fractured and unstable).



Fig. 30: Extensive remediation works: A- disposal of debris flow material; B- Early warning system; C and D- debris flow breaker during and after construction; E- two damaged roads were replaced by a temporary construction (prefabricated steel bridge); F- the new bridge.

Immediately after the event, the state and local administration for civil protection and disaster relief ordered the temporary evacuation of all inhabitants of the village, and an early warning system was put into place: the system worked based on monitored rainfall data, and several detectors that would be triggered by the heads of possible new debris flows that could be released in the destabilized source area on the Stože slope. Bridges and supply lines were also reconstructed. In the aftermath, specific legislation was adopted by the Government of the Republic of Slovenia, ordering the relocation of the houses that had been destroyed to safe areas as defined by a hazard and risk map. The Stože slope inclination was partially reduced and given freely over to natural succession (revegetation), deep drainage works were performed and torrent channels realigned. The main structural measure consisted in erecting a large 11 m high reinforced-concrete break just upstream of the village of Log pod Mangartom in the event of any future debris flows that might be triggered on the Stože slope (Fig. 30). The first phase during and immediately after the disaster (relief intervention of emergency units, especially those aimed at civil protection) can be described as Concern-Driven Crisis Management or as Judgment-Based Crisis Management, respectively. Quantitative Risk Assessment was part of the second remediation phase when legislation regarding enforcement measures was issued.

## NW SLOVENIA, ITALY AND AUSTRIA (3<sup>RD</sup> DAY)

### 7. VALCANALE VALLEY, MALBORGHETTO - VALBRUNA DEBRIS FLOW EVENTS (ITALY)

Authors: Chiara Calligaris, Chiara Boccali, Luca Zini

On 29 August 2003, a particularly intense alluvial event gave rise to more than 1,100 debris flows, which affected the municipalities of Tarvisio, Malborghetto-Valbruna and Pontebba, all situated along the Valcanale valley, in the extreme northeast of Italy (Fig. 31). The event caused two deaths, damaged 260 buildings, and large deposits were left blocking the A23 Highway; overall the damage amounted to an estimated one billion Euros (Boniello et al., 2010; Hussin et al., 2015). The extraordinary event of 2003 saw 389,6 mm of rainfall in a mere 12 hours and an estimated return time of 500 years for periods of between 3 and 6 hours (Borga et al., 2007); but this was not an exceptional isolated event for the Valcanale valley, where mean annual precipitation amounts to some 1,400 to 1,800 mm. In fact, some 20 critical rainstorms affected the valley over the last century. The magnitude of the 2003 event is comparable to those verified on 11 September 1983 and on 22 June 1996. The last decade – on 15 August 2008, 4 September 2009, and 19 June 2011 – saw smaller flash floods that created severe damage (Calligaris et al., 2012; Boccali et al., 2014). These recurring events show that the mountainous area of the Friuli Venezia Giulia Region has seen critical hydrogeological conditions increasingly frequently in recent years – probably one of the consequences of climate change (IPCC, 2013).

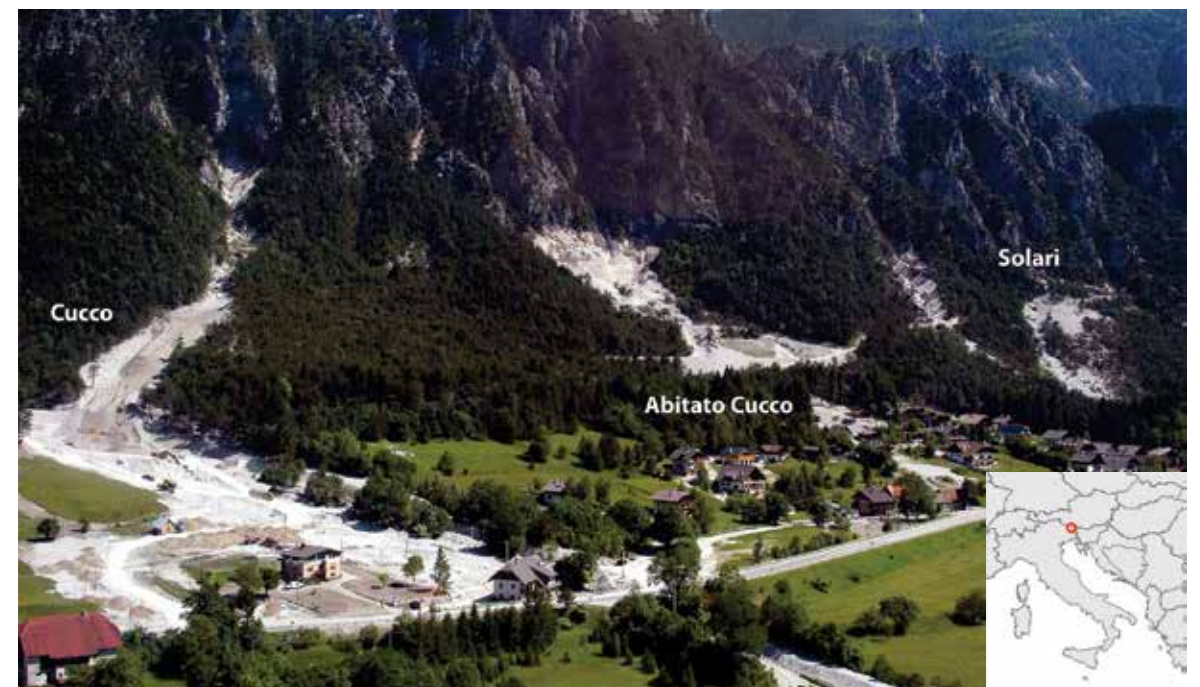

Fig. 31: Overview of the field trip area. The image has been taken just after the alluvial event which hit the valley.

The occurrence of critical rainfall events is not the only triggering factor for debris flow initiation. An important role is, in fact, played by the geological and structural asset of the area. The Valcanale valley is located at the contact of two distinct geographical and geological units: the Carnic chain and the Julian Alps and presents a significant differentiation in terms of lithotypes. The main structural element in the area is the so-called Fella-Sava line, a back-thrust E-W oriented emerging along the

valley bottom, where the Fella river flows. This back-thrust puts into contact a mixed sedimentary succession, on South, with the carbonate platform, on North. N-S and NW-SE transfer faults interrupt the continuity of the back-thrust. Small torrents cross these secondary structures and flow out in the Fella River. The tectonic stresses, associated with the heavy weathering of the mountain slopes, favor both the rock masses fracturing and the production of huge quantities of loose material, both the carrying of the debris along the secondary streams.

Along the valley floor, between the hamlets of Bagni di Lusnizza and S. Caterina, on the hydrographic right of the Fella River, it is possible to appreciate a cataclastic belt, tens of meters wide. It represents the morphological effect of the tectonic structure emerging in the area (Cucchi et al., 2008).

From a lithological viewpoint, on the hydrographic right of the Fella River, outcrop the carbonate platforms formed between the Lower Anisian and the Upper Carnian, composed by pale-grey dolostones and dolomitic limestones (Dolomia dello Sciliar). Strata are massive and only rarely layered towards the top of the sequence (Carulli, 2006).

On the hydrographic left of the Fella River, outcrop of a mixed sedimentary succession, result of different genetic environments: from the valley bottom to upstream, can be recognized bioclastic dark limestones (Bellerophon Fm. – Upper Permian), limestone, marls, sandstones and mudstones having different thicknesses and colors (Werfen Fm. – Lower Trias), massive dolostones and dolomitic limestone (Dolomia del Serla) (Fig. 32). The quaternary covers are exclusively of continental origin: mountain tills, alluvial deposits and scree slope deposits that connect the mountain rocky cliffs with the alluvial deposits of the Fella River present in the bottom of the valley. The nature of the clasts reflects the lithology of the overhead slopes: on the right side carbonates dominate; on the left, the debris is more heterogeneous, mixing the carbonate and the siliceous nature of the different outcropping rocks.

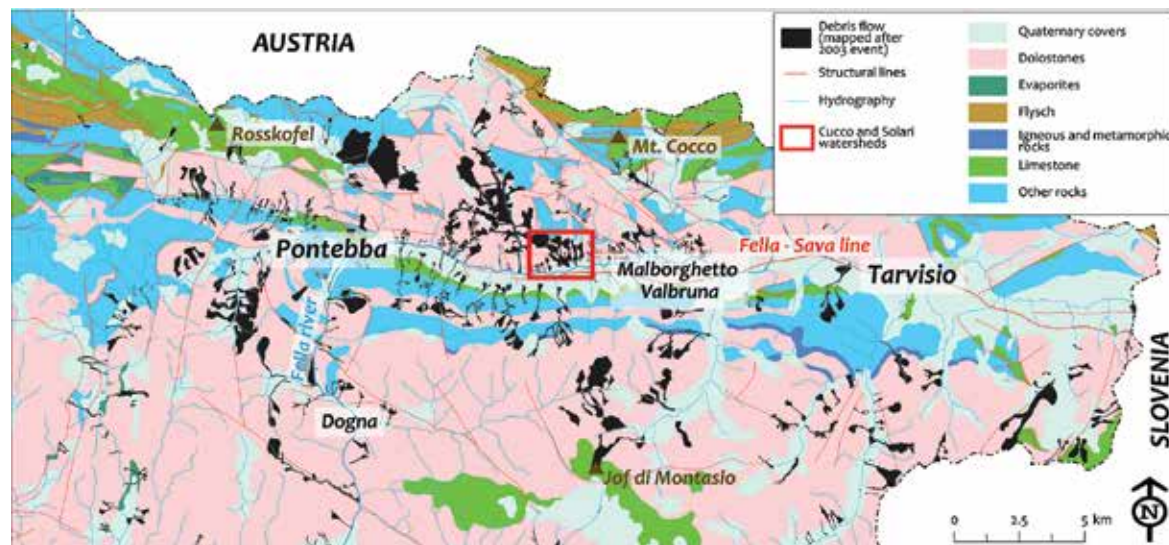

Fig. 32: Lithological map of the Valcanale valley and surroundings. In black, the debris flows mapped after the 2003 event.

In order to better understand the impact of the event that occurred in 2003, we now focus the attention on the right hydrographic side of the valley, in correspondence of the Cucco's village (municipality of Malborghetto Valbruna), in particular on three debris flow watersheds that can be considered as one of the most significant expressions of the 2003 alluvial event. All together, the three basins involved more than 100,000 m<sup>3</sup> of debris material that flowed along the wooded fans, inundated the small hamlet and reached the national road downstream finishing their motion in the Fella

River. The basins were studied separately due to their dimensions and extension, even if they present some common features, like their common morphology and the dolomitic origin of the debris material. In all cases, the source area is completely surrounded by fractured dolomitic cliffs, generated mainly by the intense tectonic stresses.

Grain size analysis, performed in the last decade along these watersheds both in the source, both in the deposition area (Silvano et al., 2004; Cucchi et al., 2008; Boccali, 2014), point out that the clay to silt content ranges from 3.75 to 20.94% of the fraction finer than 32 mm, with mean value of 9.27%. The gravel content ranges from 61.98% to 91.81%, with a mean value equal to 76.16%. All performed mineralogical analysis confirm the genetic homogeneity; in each sample, in fact, dolomite is dominant and other minerals, such as kaolinite or calcite, are present only in very reduced percentages. From East to West the basins are named "Solari" (red in Fig. 33), "Abitato Cucco" (green in Fig. 33) and "Cucco" (yellow in Fig. 33). Below the characteristics of each watershed will be described, considering also the mitigation works built up after the alluvial event of 2003.

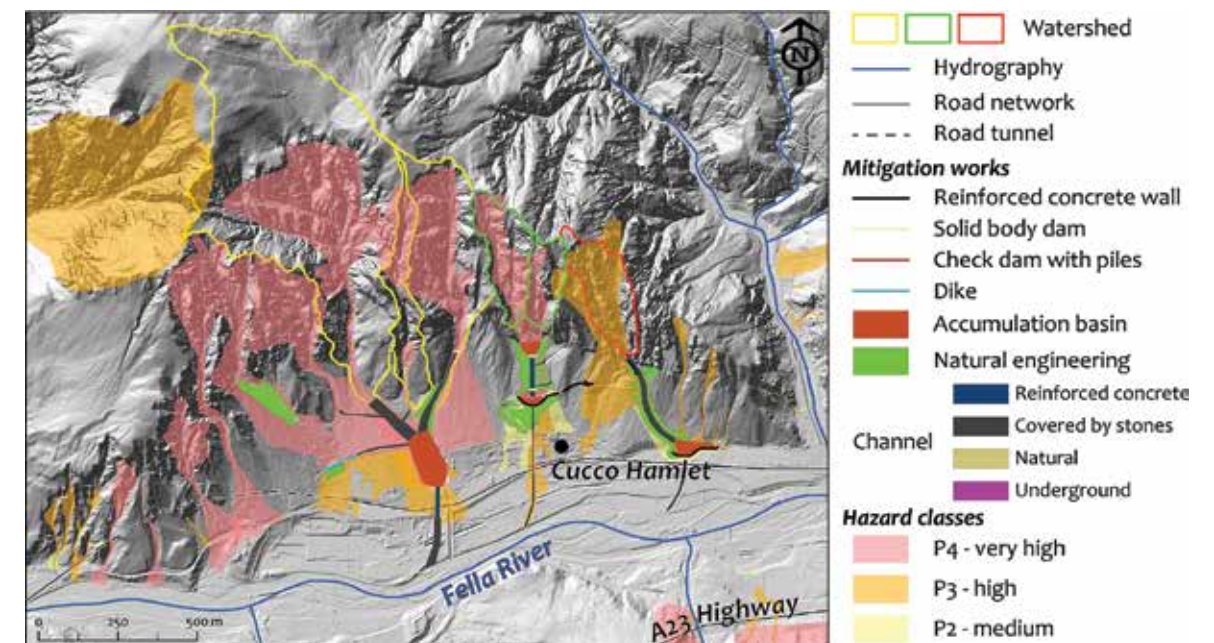

Fig. 33: Shaded relief of the slope surrounding the Cucco hamlet. The three selected watersheds are indicated with different colors: red – Solari stream, green – Abitato Cucco stream, yellow – Rio Cucco stream. Existing mitigation works and hazard delimitation are also reported.

Two paths that merge in a single gorge 100 meters before the outlet on the alluvial fan constitute the Solari stream. The two paths differ in morphology and average size of the debris material. The right one is narrow and is constituted of dolomitic clasts 0.7 m on average; the left stream is twice as wide and steeper than the other, the debris is commonly beyond the angle of repose and is composed by pebbles and gravel leant on finer material. At the confluence of the two streams, the debris is very heterometric, with a maximum size of 1 m<sup>3</sup> (Boccali et al., 2017). During 29 August 2003 event the stream overflowed and a large amount of debris (up to 4,000 m<sup>3</sup>) reached the road downstream, impeding the access at the small hamlet of Cucco. Eyewitnesses reported that the event occurred in at least two pulses, separated from each other by periods of low torrential activity (Silvano et al., 2004).

After the event, several mitigation measures were realized, completely modifying the old flow path and the preexisting morphology of the whole area. At the confluence of the stream with the fan a

weir is located, now partially destroyed; an artificial channel downstream conveys the debris through SE and many steps were created in order to brake the flow and support depositions of the larger material. The deposition basin, placed at the bottom of the fan, has a storage capacity of around 15,000-18,000 m<sup>3</sup>. Downstream of the basin a disposal channel ensures the flow of the liquid phase to the Fella River. At present, some heterogenous debris is present along the channel and the deposition basin is filled to a third by medium-fine debris (Boccali et al., 2017).

The Abitato Cucco stream is located directly upstream of the Cucco hamlet. This stream is also constituted by two paths that merge at the top of the alluvial fan. On 29 August 2003, a debris flow mobilized approximately 10,000 m<sup>3</sup> of debris, which breached an existing mitigation barrier and overpassed the retention basin. The height of deposits exceeded 2 meters and 13 to 14 houses were partially covered by the flow (Hussin et al., 2015).

After the event, two houses were relocated and important mitigation measures were built. At present, a small retention basin, measuring 2,500 m<sup>2</sup>, is located at the top of the fan, an open check dam closes the basin and conveys the material in a reinforced concrete channel (10-15 m wide, 115 m long, with a steepness equal to 25%). The channel ends with another dam and a jump of about 4 m carries the debris in another retention basin with a storage capacity of up to 9,000 m<sup>3</sup>. Downstream of this second basin another check dam, 5 m in height, conveys the water in the disposal channel to the Fella River.

Finally, the Rio Cucco debris flow involved three source watersheds that merge in the central part of the alluvial fan. The fan is partially covered by trees or meadows and several houses are located at the bottom. The lower limit is represented by the national road.

The western Rio Cucco sub-basin is bigger than the others, but less steep. The source area is composed by cataclases and the riverbed is filled by heterogeneous and heterometric material: the bigger boulders, with a mean diameter of 0.8-1 m, lean on a finer sandy matrix. Tree trunks and other woody material lean on the ground, parallel or perpendicular to the stream direction.

During 29 August 2003, three significant rainfall peaks, each of those characterized by a different flow event, interested the three watersheds (Cavalli et al., 2007). Two eyewitnesses, that gave a precise description of the entire alluvial event along the Rio Cucco stream, testified of the separation in three phases: during the first rainfall peak (between 3.30 and 5 pm) proper debris flows were not observed, while a hyper-concentrated flood caused the obstruction of the bridge at the national road. The second peak (between 5 and 6 pm) represents the paroxysmal phase and debris flows that took place in all sub-basins, with more intensity in the eastern one. The last phase, between 6 and 8 pm, was characterized by a less solid concentration of the floods and by the progressive accumulation of debris at the bottom of the alluvial fan, covering the inhabited area and a section of the national road downstream (Fig. 34a). Marchi et al. (2007) report a total volume of accumulated debris up to 100,000 m<sup>3</sup> with maximum thickness of 5 m. The existing mitigation works, consisting in three check dams and a retention basin with a storage capacity of 15,000 m<sup>3</sup> were completely destroyed and buried. The event inundated two houses.

During 2008 new mitigation works were completed: the eastern stream was conveyed in an artificial channel, made by reinforced concrete and covered by cemented stones (Fig. 34e). Two check dams also stabilize the source zone of the eastern sub-basin, but their functionality is compromised by the sub-excavation and erosion on the banks. The accumulation basin, in which all three streams merge, is designed to accommodate about 100,000 m<sup>3</sup> of debris; the conveying into the disposal canal, connected to the Fella River, is controlled by a check dam with horizontal bars (Fig. 34e).

In addition, a rheological analysis was performed on samples of Solari and Rio Cucco streams in order to define the rheological parameters (yield stress and viscosity) that govern the flow. All the samples collected in the source areas were prepared at different solid concentrations and analyzed using a controlled stress rheometer (Rheostress Haake RS150, Haake GmbH, Germany) equipped

with a parallel plate geometry with rough surfaces. The analyses were carried out through ramp tests at increasing stress levels with a geometric progression from 1 to 17,500 Pa in 450 seconds. Yield stress and viscosity were estimated through the correlation with viscoplastic flow models (Nguyen and Boger, 1992). The Bingham model can be profitably used for the experimental data collected in the shear flow region. Correlating the so-obtained values with the solid volumetric concentration (O'Brien and Julien, 1988), we gained four fitting coefficients that were afterwards used for the numerical simulations.

Finally, in Fig. 34c is reported an example of the numerous simulations performed along these watersheds using the Flo2D software. In particular, the figure shows the back analysis on the Rio Cucco stream, useful in order to identify the parameters that allow to better reconstruct the real event. These parameters were also used to run simulations on the new morphology, considering the mitigation works built up in the last decade. In general, all results confirm the efficiency of the existing structures and as such it was possible to decrease the risk in the areas protected by the above-mentioned mitigation works.

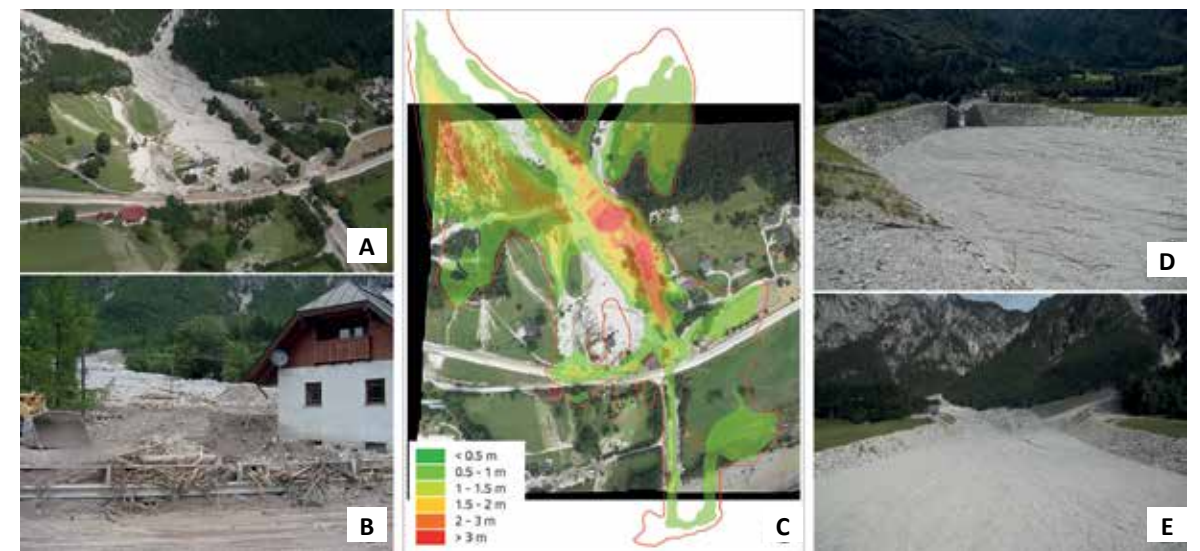

Fig. 34: Rio Cucco stream: A, B- Photos taken just after the debris flow of 29 August 2003; C-back analysis performed with Flo-2D; D- check dam at the closure of the accumulation basin; E- outlet of the three paths in the accumulation basin.

## 8. DOBRATSCH ROCKSLIDES (AUSTRIA)

Author: Jürgen M. Reitner

The Dobratsch massif (Fig. 35, Fig. 36), also known as the Villacher Alpe, with its highest peak at 2,166 m a.s.l., is located west of the city of Villach on the northern flank of the Gail Valley (valley floor at 550 m a.s.l.), which follows the Periadriatic Fault. It represents the eastern most part of the Gailtal Alps, a mountain chain on the southern flank of the Eastern Alps south of the Hohen Tauern mountain chain. The Dobratsch massif is a popular recreation area with an excellent panoramic view which is easily reached from Villach via the Villacher Alpenstraße mountain road. The Dobratsch and its southern foreland, the so called "Schütt", are a protected landscape of the "Naturpark (nature park) Dobratsch" and include two NATURA 2000 areas according to the European Union.

### THE GEOLOGY OF THE DOBRATSCH (VILLACH ALPS)

The Dobratsch belongs tectonically to the Drauzug-Gurktal nappe system of the Austroalpine Superunit (Schmid et al., 2004). Its southern limit is given by the E-W trending Periadriatic Fault, a major strike-slip fault which runs in the glacially overdeepened Gail Valley (Fig. 35, Fig. 36, Fig. 37) and delimitates the Austroalpine from the South Alpine Superunit. Towards the basin of Villach in the east, the massif shows a stair-cased normal faulting along N-S trending faults (Colins & Nachtmann, 1978). A thrust plane separates a lower and an upper tectonic unit (Fig. 38).



Fig. 35: The Dobratsch massif and its surrounding viewed from SE and the E-W running Gail Valley in the south. Multiple scarps on its southern flank are evident (e.g. Rote Wand- RW). The woods at the toe and its immediate southern foreland, (the so called Schütt) cover the prehistoric and historic rock avalanche deposits. In addition, the location of the town of Villach at the confluence of the rivers Gail and Drau, and that of the village of Arnoldstein (A) are indicated. Towards North, the still glaciated peaks with altitudes of up to 3,360 m a.s.l. of the Hohe Tauern mountain range can be seen.

The massif consists at the base of red sandstone and conglomerates (Gröden Fm.) and grey to violet sandstones, siltstones, claystones and Rauhwaacke (cellular or porous limestone or dolostone indicating the former presence of gypsum) (Werfen Fm.) of Permian to Lower Triassic age (Fig. 37, Fig. 38; Anderle, 1977; Colins and Nachtmann, 1978). Triassic limestone and dolostone (dominantly Wetterstein Fm.) make up the overwhelming part of the massif. The strata gently dip with 30-60° into the slope (towards north). Joints along the southern flank show a dominant E-W trend, parallel to the Gail Valley and thus the Periadriatic fault (Brandt, 1981; v. Hütschler, 1981). N-S running joints occur subordinately. The Dobratsch massif with its staircased topography is regarded as a remnant of an "old" pre-Miocene landscape which was dissected in response to Miocene tectonics i.e. the lateral extrusion of the Eastern Alps (for details see Frisch et al., 2000). Dolines, caves and springs prove intensive Karstification along pre-existent tectonic planes.



Fig. 36: A topographic map (base map: BEV) with shaded relief (provided by Land Kärnten data.gv.at) of the Dobratsch Site with the location of the Stop at Arnoldstein.

During the climax of Last Glacial Maximum (Würmian Pleniglacial; appr. 27-19 ka) the peak of the Dobratsch was a Nunatak which overtopped the ice-surface of the Drau Glacier in 1,500-1,600 m a.s.l. (van Husen, 1987). Such glacial erosion resulted in oversteepening of the southern slope and a substantial overdeepening of the Gail Valley (in the range of more than 200 m). Glacially molded bedrock surfaces partly covered by subglacial till in the southern foreland of the Dobratsch are further evidence of glacial action and provide a sharp morphological contrast to the adjacent areas made up of rock avalanche deposits.

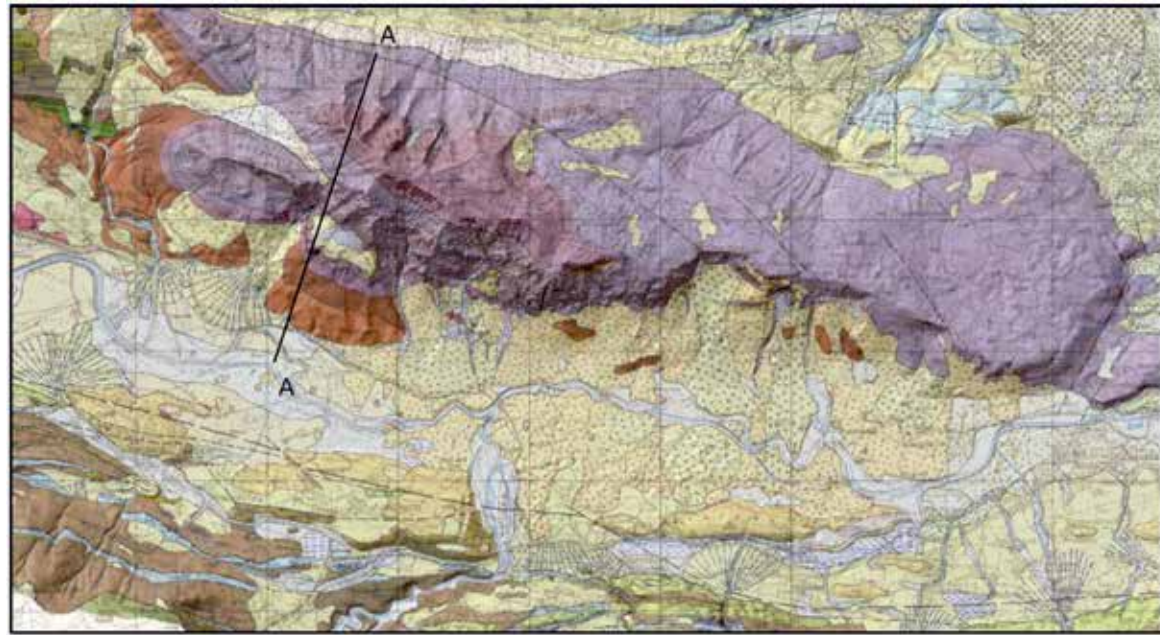

**Legend**



Fig. 37: Geological map of the Dobratsch massif (Villach Alps; Anderle, 1977).

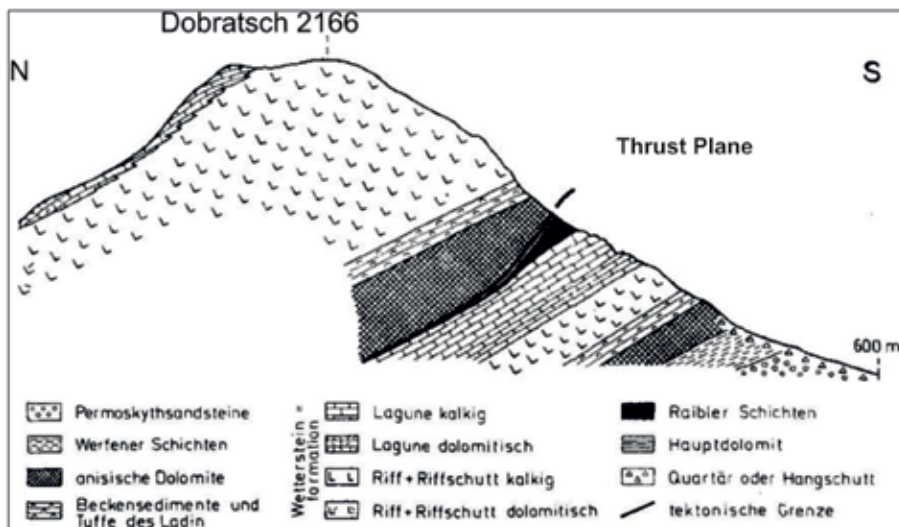

Fig. 38: A simplified N-S geological cross section through the mountain of Dobratsch, A-A (for the location of the cross section see Fig. 37). A thrust plane (reverse fault) separates two tectonic units (after Colins and Nachtmann, 1978).

**THE DOBRATSCH ROCK AVALANCHE EVENTS**

Multiple scarps on the glacially oversteepened southern flank of Dobratsch testify to different phases of slope failure (Fig. 39). The area below comprises the largest area of the Eastern Alps, with 23 km<sup>2</sup> covered by rock avalanche deposits of historic and prehistoric age (Till, 1907).

a) The pre-historic rock avalanche events

Weathered scarps, with yellow-grey, grey to reddish-grey colors mark the detachment areas of the pre-historic events predominantly on the western part of the southern flank of Dobratsch (Till, 1907). The corresponding deposits in the area of the so-called "Alte Schütt" cover an area of 16 km<sup>2</sup> with an estimated volume of 800- 900 x 10<sup>6</sup> m<sup>3</sup> (Brandt, 1981). Weathered boulders and megaboulders (> 100 m<sup>3</sup>) with rounded edges and karren (karst features) on its surface, which forms hills of up to 80 m in height (Krainer, 2013) and evident soil formation are characteristic for these older deposits (Fig. 40). The type of vegetation depends on the degree of soil development, but it mainly comprises mixed forests of Pine, Scots Pine, Spruce, and Beech. The age of these events is still a matter of discussion. However, the old view by Abele (1974), that the hummocky terrain consisting of cone-shaped so-called Toma hills proof rock avalanches falling down on a down-wasting glacier (dead ice) during ice-decay at the end of the LGM has been refuted like in so many cases in the Eastern Alps (cf. Prager et al., 2008). Drillings for the motorway A2, which runs through the area, did not show the rock avalanche deposits but alluvial deposits indicating an event at least after the glacially over-deepened Gail valley was already infilled by deltaic and fluvial sediments in the Lateglacial. However, Till (1907) also supposes an earth-quake triggering for the pre-historic events.

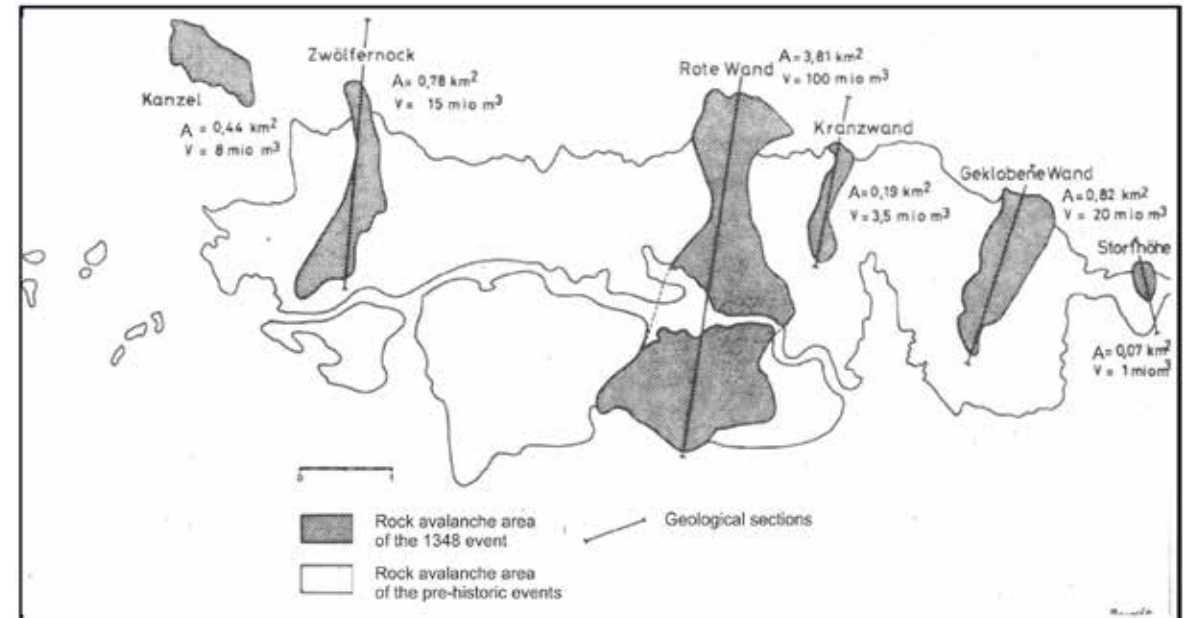

Fig. 39: A sketch of the rockslide events following the earthquake on 25 January 1348 (after Brandt, 1981). A – area; V – volume.



Fig. 40: A- Deposit of the pre-historic rock avalanche event in the area of the “Alte Schütt” with typical vegetation cover. B- Soil formation on top of the pre-historic deposit.

b) The rock avalanche event of the year 1348, its aftermath and legacy

The six historic rock avalanches were triggered on the 25 January 1348 by one of the strongest historically recorded earthquakes in the Eastern Alps with an epicentral intensity of  $I_0 = 9-10$  (MCS) (Hammerl, 1994). However, the location of the epicenter of this earthquake is still a matter of discussion. As this earthquake most probably triggered the Velki Vrh rock avalanche in Slovenia (50 km ESE of Dobratsch) (Merchel et al., 2014) as well as other rock fall events the view of an epicenter in Friuli, Italy (Hammerl, 1994; Lenhardt, 2007) is questioned. According to Decker et al. (2016), either the epicenter of the event must have been located close to the town of Villach, or the epicentral intensity must have been significantly larger than  $I = 10$  when assuming an epicenter at a larger distance from Villach, e.g., in Friuli.



Fig. 41: Area of the “Junge Schütt” made up of the deposits from the year 1348, rock avalanche deposits with sparse vegetation.

The deposits from the year 1348 cover an area of the pre-historic event with an overlay with a thickness of 20- 30 m that (Till, 1907; Brandt, 1981). Thus, the deposition of historic rock-avalanche occurred in an unoccupied landscape which explains no immediate fatalities due to the event. The depositional area is called the “Schütt” or also “Steinmeer” (German for “sea of stones”) and shows no soil or only initial soil formation. Consequently, they are only sparsely vegetated with small pines and other plants of an early vegetational succession (Fig. 41). The surface consists predominantly of boulder and mega-boulders that are less weathered i.e. have sharp edges and show only limited signs of corrosion. Occasional outcrops show a layer of angular boulders and megaboulders (“carapace facies”; according to Dunning, 2004) which rest on finer, matrix-supported clastic material (Body Facies; Dunning, 2004).

The historical rock avalanches caused a damming of the River Gail and the formation of a lake 2km<sup>2</sup> with a maximum length of 3 km and a water depth of 15 m, which finally destroyed two villages (Neumann, 1988). The last remnants of this lake lasted until the 18th century and are still evident in local names like “Seewiese” (German for “lake meadow”). Two hydroelectric installations exploit the hydraulic head created by the debris lobe across the River Gail (cf. Eisbacher and Clague, 1984).

c) Failure mechanism of the Dobratsch Rockslides

According to the reconstruction by Brandt (1981), the mechanical differences between “hard” carbonatic rocks on top and “weak” silt to sandstones at the base enabled, together with partly karstified faults and joints, the development of cracks and, eventually, a sliding plane. Finally, the detached and fragmented rock mass behaved like a flow typical for a rock avalanche which reached its long run-out due to the mechanisms of dynamic fragmentation (McSaveney and Davies, 2006; Davies and McSaveney, 2009). This can be best studied for the “Rote Wand” event (Fig. 42) which has the biggest volume  $100 \times 10^6 \text{ m}^3$  and the lowest Fahrböschung (travel angle) of  $11^\circ$  of all historic rock avalanches (Brandt, 1981). The most pronounced fracture system is evident at the steep cliff of the “Rote Wand” (German for “Red Wall”; Brandt, 1981), which has a height of appr. 350 m. This is the detachment area of the largest rock avalanche event which occurred in the year 1348. Deep tensional cracks on top of the rock wall on the western flank of “Rote Wand” indicate most likely ongoing slope failure as a result of the aforementioned “hard rock on top of weak rock” situation. The multiple sliding surfaces here are remarkable; all steeply inclined towards the south at around  $50^\circ$  (Fig. 43). The slide planes are very smooth and usually have slickensides structures. On the southwestern part of the “Rote Wand” are rock towers that reach heights of over 100 m.

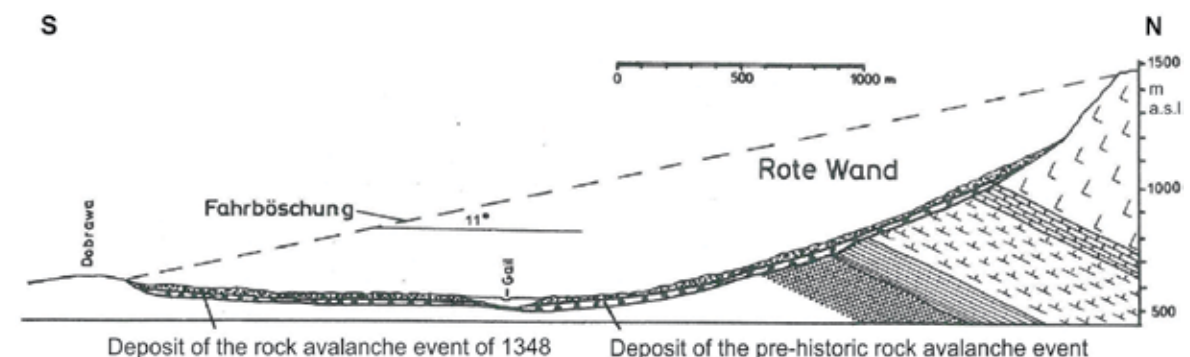

Fig. 42: Cross-section from the scarp to the deposits of the historic Rote Wand rock avalanche event (location indicated in Fig. 39).

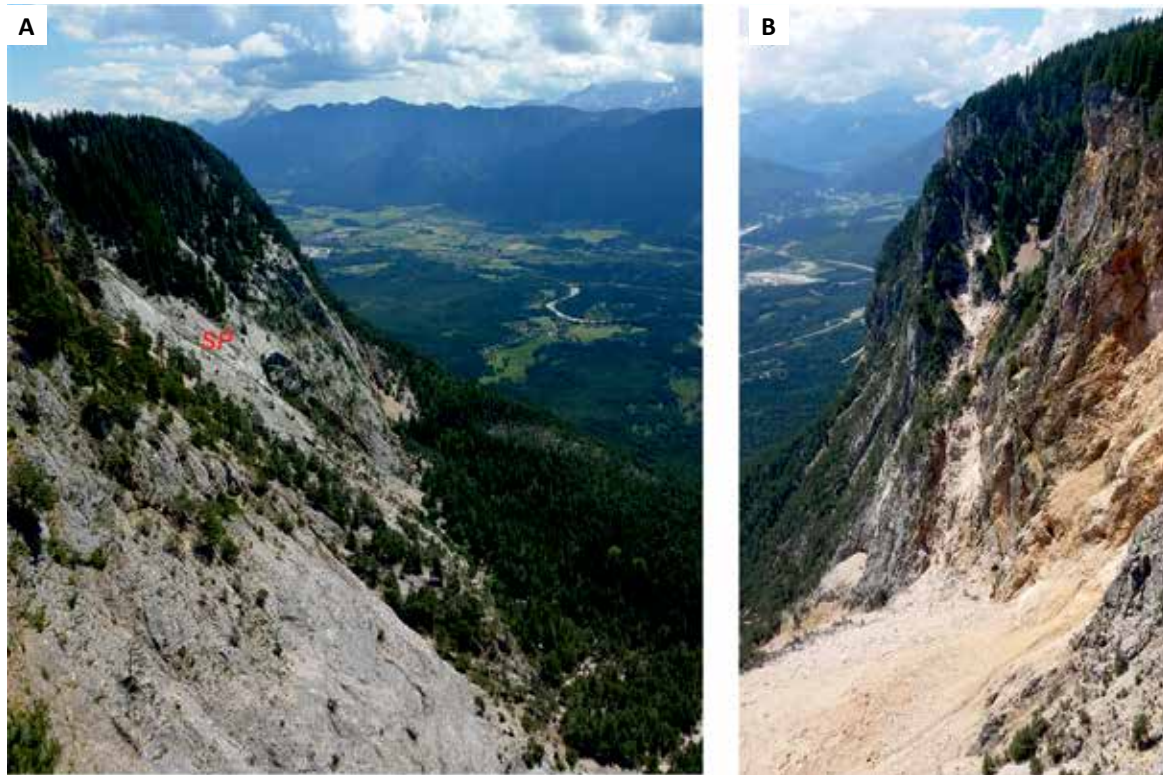

Fig. 43: A- Sliding plane (SP) in the western part of the Rote Wand scarp formed during the event of 1348. B- Eastern part of the Rote Wand scarp with the deposits of recent rock fall deposit.

### RECENT ROCK FALLS

According to Brandt (1981) rock mass falls larger than 100,000 m<sup>3</sup> and thus a travel angle of below 25- 30° are unlikely. Recent events at the “Rote Wand” scarp (Fig. 43) had a volume of 40,000 m<sup>3</sup> at maximum. Hence, no endangerment of settlements or traffic infrastructure is evident so far. However, open tension cracks along the flanks indicate ongoing loosening of the steep cliff and the preparation of further rock mass fall events.

## 9. POTOŠKA PLANINA LANDSLIDE

Author: Tina Peternel, Jošt Sodnik

The Potoška planina landslide is located in the Karavanke mountain range (NW Slovenia) above the densely populated settlement of Koroška Bela, which has almost 2,200 inhabitants (Fig. 44). Current landslide activity is evidenced by the “pistol butt” trees, scarps, open longitudinal cracks (Fig. 45) and the deformation of local roads. Similarly, historical sources describe a severe debris flow at the end of the 18th century that destroyed nearly 40 houses in the village of Koroška Bela. In total the landslide covers an area of 0.2 km<sup>2</sup> with an estimated maximum volume of sliding mass of roughly 1.8 × 10<sup>6</sup> m<sup>3</sup> (Jež et al., 2008; Komac et al., 2015). In general, the broader area of the Potoška planina area exhibits highly complex geological and tectonic characteristics, which exert an influence on various slope mass movements. The upper part of the landslide consists of carbonate rocks and scree deposits that are largely prone to rock slides (Fig. 44B), while the main body of the landslide consists of heavily deformed Upper Carboniferous and Permian clastic rocks, which are characterized by complex dynamic movement, and is presumed to be a rotational, deep-seated slow-motion slide accelerated by the percolation of surface and groundwater (Jež et al., 2008; Komac et al., 2015, Peternel et al., 2017) (Fig. 44A). Due to the several springs at the contact point between scree and fine grained clastic rocks the landslide area is partially covered by wetlands, and the Bela stream increases the possibility of mobilization of the material into debris flow (Peternel et al., 2017). Based on UAV photogrammetry and tachymetric measurements, Peternel et al. (2017) monitored the toe of the landslide where, during an observation period of nearly two years, the assessed displacements ranged between 0.9 and 17.9 m (Fig. 46). As a prevention measure, a recording system that provides real-time monitoring of landslide behavior was installed as part of the European project Recall, which can play a role in the process of establishing an EWS in the future (Jemec Auflič et al., 2017).

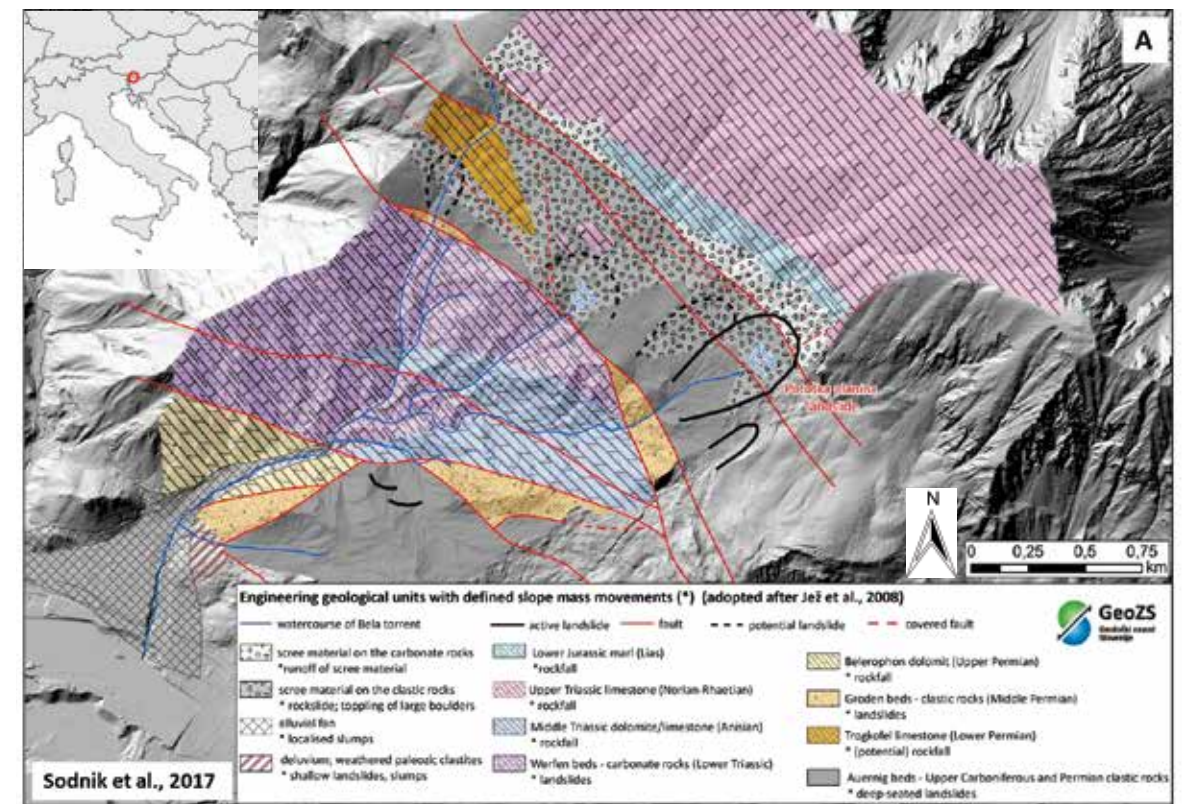





Fig. 44: A- Engineering geological map of watershed of Bela torrent with its hinterland (adopted by Jež et al., 2008). For each engineering unit a type of slope mass movements was defined based on field surveying (Sodnik et al., 2017); B- Panoramic view from Kočna to the Belčica limestone ridge and Potoška planina. C- View from the Belčica limestone ridge, looking directly down to the Potoška planina landslide onto the village of Koroška Bela that lies on the alluvial fan.



Fig. 45: Longitudinal cracks and stretching of tree roots in the Carboniferous and clastic rocks.

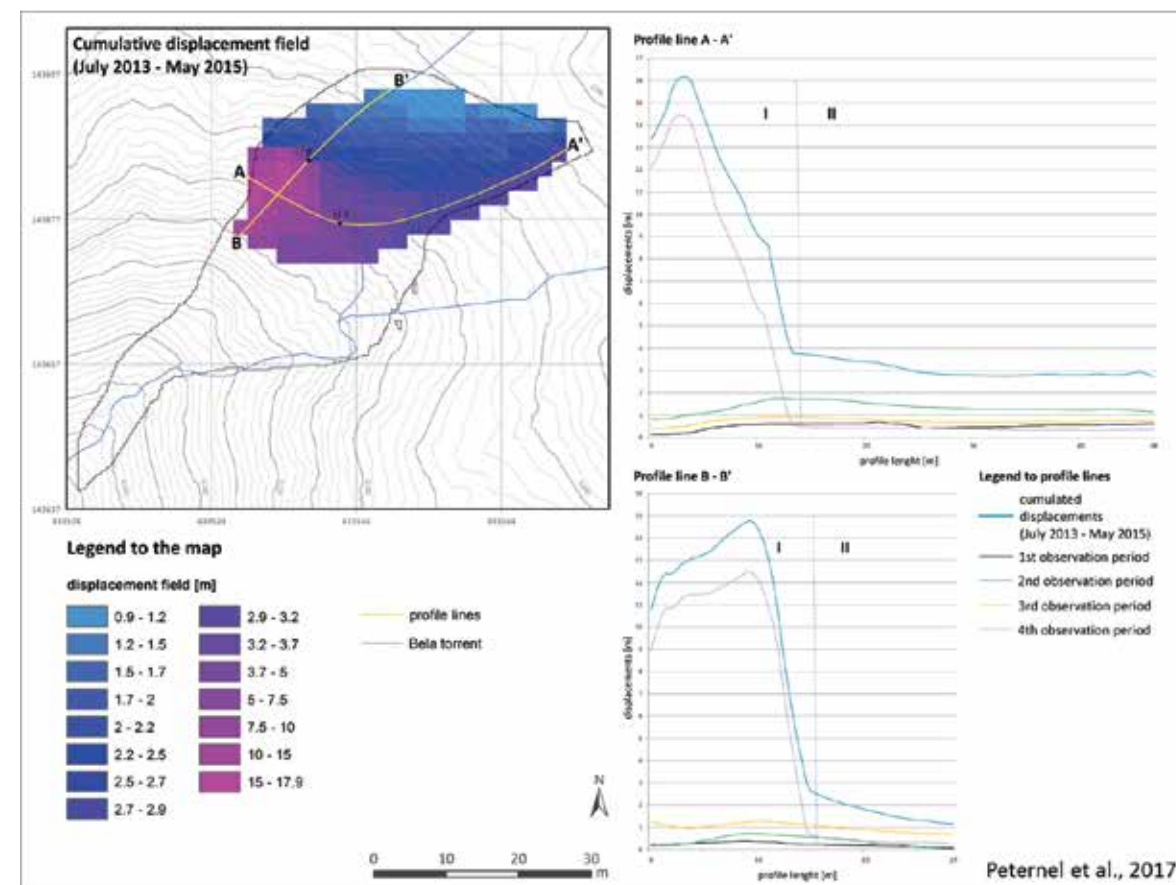

Fig. 46: Cumulative displacement field obtained with UAV photogrammetry and characteristics profiles that represent behavior of the lower part of Potoška planina landslide (Peternel et al., 2017).

Debris flow hazard assessment for potential debris flow events is or should be a very important part in the spatial planning process. Debris flow magnitude of potential debris flow is one of the key parameters for debris flow hazard assessment. LS-Rapid triggering model was applied to identify unstable areas in Bela torrent watershed. Modeling results could be used for potential debris flow magnitude estimation in the process of debris flow hazard assessment. Modelling results were validated with field survey where all unstable and potentially unstable areas were identified (Sodnik et al., 2017). Modeling results show good agreement with identified areas with field survey (Fig. 47).

In the final phase of debris flow hazard assessment (hazard mapping), mathematical modeling of debris flow on torrential fan is crucial for reliable debris flow hazard maps. Topographical data are very important input data and have significant impact on the results (Sodnik et al., 2017). Different sets of data were used and results were compared in terms of results (maximum flow depths, maximum flow velocities and computational times) to determine optimal set of topographic data for mathematical modeling in process of debris flow hazard assessment (Fig. 48).

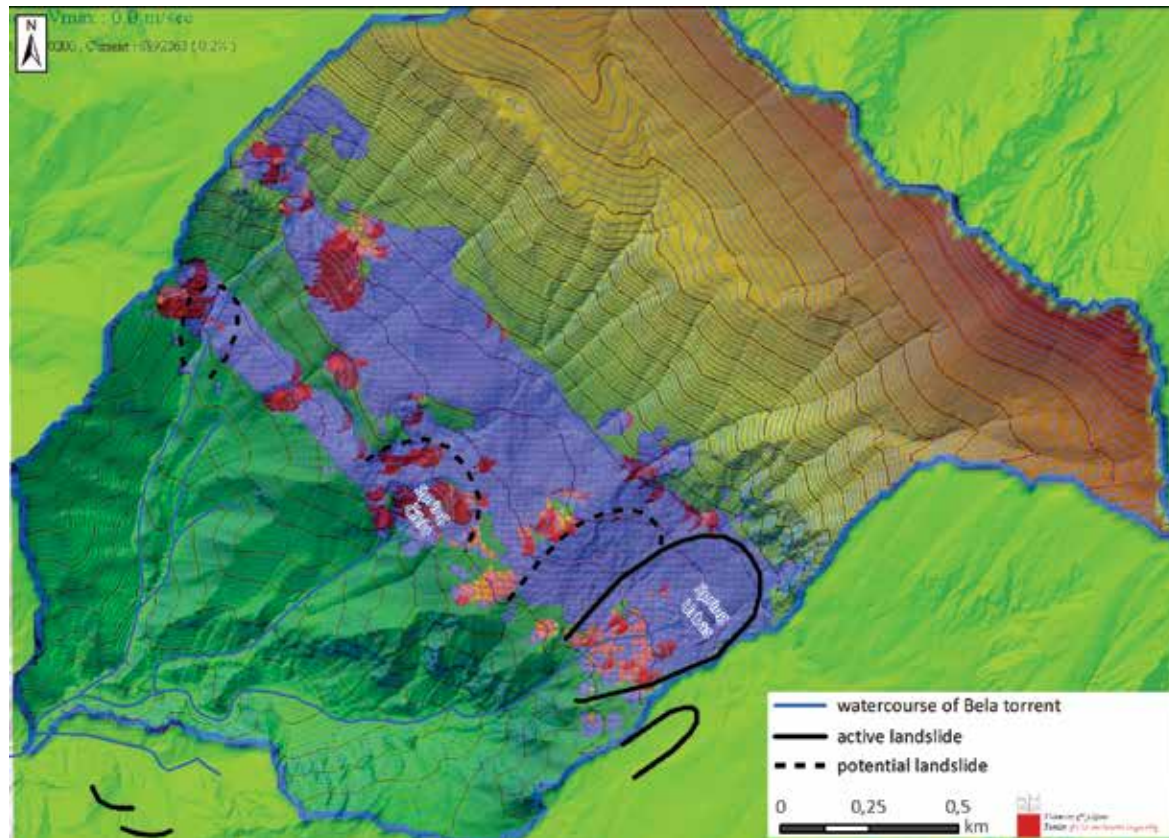

Fig. 47: Results of the LS-Rapid model with field survey identified areas (Sodnik et al., 2017).

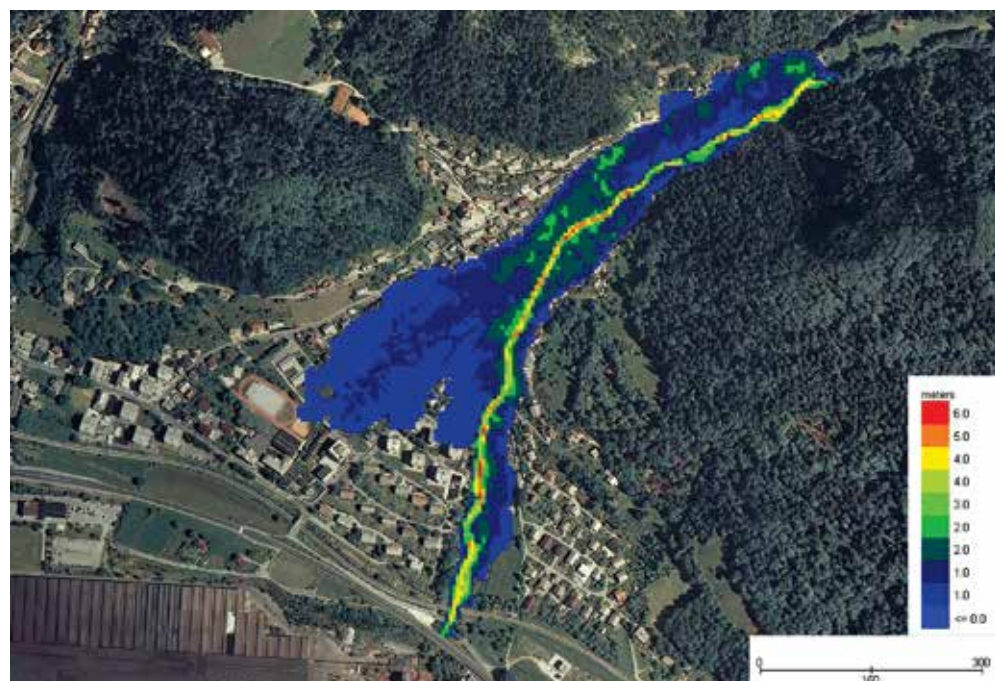

Fig. 48: Maximum flow depths of potential debris flow on Koroška Bela fan (Sodnik et al., 2012).

## REFERENCES

- Abele G (1974) Bergstürze in den Alpen. Ihre Verbreitung, Morphologie und Folgeerscheinungen.- Wissenschaftliche Alpenvereinshefte 25: 1-230.
- Anderle N (1977) Geologische Karte der Republik Österreich 1:50,000, Blatt 200, Arnoldstein. Geologische Bundesanstalt (Geological Survey of Austria), Vienna.
- Benko, I. 2011. Historical overview of intervention at Slano blato landslide = Zgodovinski pregled intervencij na plazu Slano blato. in: Petkovišek, A., et al. (eds), Zbornik referatov 12. Šukljjetovi dni, Sloged, Ljubljana: 53-63.
- Boccali C (2014) Caratterizzazione e modellazione di colate detritiche. Phd Thesis, University of Trieste, 205 pp.
- Boccali C, Calligaris C, Zini L, Cucchi F, Lapasin R (2014) Comparison of scenarios after ten years: the influence of input parameters in Val Canale valley (Friuli Venezia Giulia, Italy). G Lollino et al. (eds.), Engineering Geology for Society and Territory 2: 525-529.
- Boccali C, Lapasin R, Zini L, Calligaris C, Cucchi F (2017) Characterization and modeling of a debris flow in a dolomitic basin: results and issues. 4th World Landslide Forum proceedings by Springer Nature publishing, in press.
- Boniello MA, Calligaris C, Lapasin R, Zini L (2010) Rheological investigation and simulation of a debris-flow event in the Fella watershed, Nat. Hazards Earth Syst. Sci 10: 989-997.
- Borga M, Boscolo P, Zanon F, Sangati M (2007) Hydrometeorological analysis of the 29 August 2003 flash flood in the eastern Italian Alps, Journal of Hydrometeorology: 1049-1067.
- Brandt A (1981) Die Bergstürze an der Villacher Alpe (Dobratsch), Kärnten/Österreich Untersuchungen zur Ursache und Mechanik der Bergstürze. Ph.D. thesis. University Hamburg, Germany.
- Calligaris C, Zini L, Cucchi F (2012) Debris follow rainfall thresholds in Val Canale Valley: first steps into their redefinition. WIT Transactions on Engineering Sciences 73: 49-57. doi: 10.2495/DEB120051.
- Carulli GB (2006) Carta Geologica del Friuli Venezia Giulia, scala 1:150000. Regione Friuli Venezia Giulia, S.EL. CA. Firenze.
- Cavalli M, Marchi L, Sangati M, Zanon F, Borga M (2007) Erosione e trasporto dei sedimenti durante una piena improvvisa: l'evento del rio Cucco, 29 Agosto, Idronomia Montana 27(2), 14 pp.
- Colins E, Nachtmann W (1978) Geologische Karte der Villacher Alpe (Dobratsch, Kärnten).- Mitteilungen der Gesellschaft der Geologie- und Bergbaustudenten in Österreich 25: 1-10.
- Cucchi F, Calligaris C, Zini L (2008) Relazione tecnico illustrativa delle attività scientifiche finalizzata alla realizzazione di uno studio geologico tecnico relativo ai fenomeni di colata detritica in Val Canale, Regione Autonoma Friuli Venezia Giulia, Direzione centrale ambiente e lavori pubblici, Open File Rep. 8913, 156 pp.
- Davies TR, McSaveney MJ (2011) Rock-avalanche size and runout-implications for landslide dams. Natural and Artificial Rockslide Dams: 441-462.
- Decker K, Gangl G, Reitner JM (2016) Constraints on the location of the earthquake 1348 of Carinthia, Friuli, Villach derived from its ESI-2007 environmental intensity. In GeoTiro 2016: Annual Meeting DGGV: 25-28 September 2016, Innsbruck, Austria: Abstract Volume (2016): 47.
- Dunning SA (2004) Rock avalanches in high mountains. PhD thesis. University of Bedfordshire, 309 pp.
- Eisbacher GH, Clague JJ (1984) Destructive Mass Movements in High Mountains: Hazard and Management.- Geological Survey of Canada Paper 84-16, 230pp.
- Fifer Bizjak K, Zupančič A (2009) Site and laboratory investigation of the Slano blato landslide. Engineering Geology 105(3-4): 171-185.
- Frisch W, Székely B, Kuhlemann J, Dunkl I (2000) Geomorphological evolution of the Eastern Alps in response to Miocene tectonics. In Zeitschrift für Geomorphologie: Neue Folge 44: 103-138.
- Hacquet, B. (1789). Oryctographia Carniolica oder Physikalische Erdbeschreibung des Herzogthums Krain, Istrien und zum Thiel der benachbarten Länden.
- Hammerl C (1994) Das Erdbeben vom 25. Jänner 1348 – Eine historische Rekonstruktion. In: Neues aus Alt-Villach 31. Jahrbuch des Stadtmuseums: 55-94.

Hussin H.Y, Ciurean R, Frigerio S, Marcato G, Calligaris C, Reichenbach P, Van Westen C.J, Glade T (2015) Assessing the effect of mitigation measures on landslide hazard using 2D numerical runout modelling. *Landslide Science for a safer geoenvironment 2*: 679-684.

Hütschler C. (1981) Die Bergstürze am Dobratsch – Eine tektonische und geomechanische Analyse. Unveröff. Diss. Hamburg.

IPCC (2013) Summary for Policymakers. In TF Stocker, D Qin, GK Plattner, R Tignor, SK Allen, J Boschung, A Nauels, Y Xia, V Bex, PM Midgley (eds.), *Climate Change 2013: The Physical Science Basis, Contribution of Working Group I to the Fifth Assessment Report of the Intergovernmental Panel on Climate Change*, Cambridge University Press, Cambridge, UK & USA.

Jemec Auflič M, Peternel T, Kumelj Š, Jež J, Milanič B, Dolžan E, Brunelli G (2017) RECALL project: Toward resilient European Communities against local landslides. 4th World Landslide Forum proceedings by Springer Nature publishing, in press.

Jež J (2007) Reasons and mechanism for soil sliding processes in the Rebrnice area, Vipava valley, SW Slovenia. *Geologija* 50(1): 55-63.

Jež J, Mikoš M, Trajanova M, Kumelj Š, Budkovič T, Bavec M (2008) Vršaj Koroška Bela – Rezultat katastrofičnih pobočnih dogodkov. *Geologija* 51 (2): 219–227 (in Slovenian with English abstract)

Jež J, Atanackov J, Čarman M (2001) How tectonics drive mass movement? : an example from Vipava valley, western Slovenia. V: BAROŃ, Ivo (ed.), JABOYEDOFF, Michel (ed.). *Slope tectonics 2011 : eletronic proceedings of the 2nd Conference on Slope Tectonics : 6-10 September 2011, Vienna*. Vienna: Geological Survey of Austria, 2011, 13p.

Komac M, Holly R, Mahapatra P, Van der Marel H, Bavec M (2015) Coupling of GPS/GNSS and radar interferometric data for a 3D surface displacement monitoring of landslides. *Landslides* 12: 241-257.

Košir A, Popit T (2017) The Selo landslide complex (Vipava Valley, SW Slovenia): a long runout rock avalanche developed from a large rock-slope failure? 4th World Landslide Forum proceedings by Springer Nature publishing, in press.

Krainer K (2013) Die Bergstürze des Dobratsch. In B Golob, M Jungmeier, E Kreimer (ed.), *Natur & Mensch in der Schütt. Die Bergsturzlandschaft im Naturpark zwischen Dobratsch und Gail* Verlag des Naturwissenschaftlichen Vereins für Kärnten: 57-64.

Lenhardt WA (2007) Earthquake-Triggered Landslides in Austria - Dobratsch Revisited. *Jahrbuch der Geologischen Bundesanstalt*: 147, 193-194.

Legros F (2002) The mobility of long-runout landslides. *Engineering Geology* 63(3-4): 301-331.

Logar J, Fifer Bizjak K, Kočevar M, Mikoš M, Ribičič M, Majes B (2005) History and present state of Slano blato landslide. *Natural Hazards and Earth System Sciences*. 5: 447–457.

Maček M, Majes B, Petkovšek A (2016) Lessons learned from 6 years of suction monitoring of the Slano blato landslide. *Rivista Italiana di geotechnica* 1: 21–31.

Majes B, Petkovšek A, Logar J (2002) The comparison of material properties of debris flows from Stože, Slano blato and Strug landslides. *Geologija* 45(2): 457–463 (in Slovenian with English abstract)

Marchi L, Cavalli M, Sangati M, Borga M (2007) Hydrometeorological controls and erosive response of an extreme alpine debris flow. *Hydrol. Process*. 23: 2714-2727.

Martín Pérez A, González- Acebrón L, Košir A, Popit T (2016) Sandstone diagenesis, salt-induced weathering and landslide formation: the case of Slano Blato Landslide, Slovenia. 32nd IAS International Meeting of Sedimentology, Marrakech

McSaveney MJ, Davies T (2006) Inferences from the morphology and internal structure of rockslides and rock avalanches rapid rock mass flow with dynamic fragmentation. In GE Evans, GS Mugnozza, A Storm, RL Hermanns (eds.), *Landslides from Massive Rock Slope Failure*: 285-304.

Merchel S, Mrak I, Braucher R, Benedetti L, Repe B, Boulès DL, Reitner JM (2014) Surface exposure dating of the Veliki vrh rock avalanche in Slovenia associated with the 1348 earthquake. *Quaternary Geochronology* 22: 33-42.

Mikoš M, Četina M, Brilly M (2004) Hydrologic conditions responsible for triggering the Stože landslide, Slovenia. *Engineering Geology* 73(3-4): 193-213.

Mikoš M, Brilly M, Fazarinc R, Ribičič M (2006a) Strug landslide in W Slovenia: A complex multi-process phenomenon. *Engineering Geology* 83(1-3): 22-35.

Mikoš M, Fazarinc R, Ribičič M (2006b) Sediment production and delivery from recent large landslides and earthquake-induced rock falls in the Upper Soča River Valley, Slovenia. *Eng Geol* 86: 198-210.

Mikoš M, Petkovšek A, Majes B (2009) Mechanism of landslides in over-consolidated clays and flysch. *Landslides* 6: 367–371.

Mikoš M, Vidmar A, Brilly M (2005) Using a laser measurement system for monitoring morphological changes on the Strug rock fall, Slovenia. *Natural Hazards and Earth System Sciences* 5(1): 143-153.

Neumann D (1988) Lage und Ausdehnung des Dobratschbergsturzes von 1348. In *Neues aus Alt-Villach Jahrbuch des Museums der Stadt Villach* 25: 69-77.

Nguyen QD, Boger DV (1992) Measuring the flow properties of yield stress fluids. *Annu Rev Fluid Mech* 24: 47-88.

O'Brien JS, Julien PY (1988) Laboratory analysis of mudflow properties. *J. Hydraul. Eng.* 114 (8): 877-887.

Peternel T, Kumelj Š, Oštir K, Komac M (2017) Monitoring the Potoška planina landslide (NW Slovenia) using UAV photogrammetry and tachymetric measurements. *Landslides* 14, 1: 395 – 406.

Petkovšek A (2001) Geological-geotechnical investigations of the Stože landslide. *Ujma*, 2000/2001, 14/15, 109-117.

Petkovšek A, Fazarinc R, Kočevar M, Maček M, Majes B, Mikoš M (2011) The Stogovce landslide in SW Slovenia triggered during the September 2010 extreme rainfall event. *Landslides* 8(4): 499-506.

Petkovšek A (2006). The influence of matrix suction on strength and stiffness of soils = Vpliv matrične sukcije na trdnostno deformacijske lastnosti zemljin, PhD thesis, University of Ljubljana, Faculty of Civil and Geodetic Engineering, Ljubljana, 213 p.

Petkovšek A, Maček M, Kočevar M, Benko I, Majes B (2010). Soil matric suction as an indicator of the mud flow occurrence in: Croatia–Japan project on risk identification and land-use planning for disaster mitigation of landslides and floods in Croatia 1st project workshop „international experience“, Dubrovnik (Croatia).

Petkovšek A, Maček M, Mikoš M, Majes B (2013). Mechanisms of Active Landslides in Flysch. in: Sassa, K., et al. (edr.) *Landslides: Global Risk Preparedness*. Springer Verlag, cop., Berlin. 149-164.

Placer L (1981) Geologic structure of southwestern Slovenia = Geološka zgradba jugozahodne Slovenije. *Geologija* 24(1): 27-60.

Placer L, Jež J, Atanackov J (2008) Strukturni pogled na plaz Slano blato = Structural aspect on the Slano blato landslide (Slovenia) *Geologija* 51(2): 229-234.

Popit T, Košir A, Šmuc A (2013) Sedimentological Characteristics of Quaternary Deposits of the Rebrnice Slope Area (SW Slovenia). V *Knjiga sažetka. 3. znanstveni skup Geologija kvartara u Hrvatskoj s međunarodnim sudjelovanjem, Zagreb, 21st–23rd March 2013*. Zagreb, HAZU.

Popit T, Rožič B, Šmuc A, Kokalj Ž, Verbovšek T, Košir A (2014) A lidar, GIS and basic spatial statistic application for the study of ravine and palaeo-ravine evolution in the upper Vipava valley, SW Slovenia. *Geomorphology* 204: 638-645.

Popit T, Košir A (2003) Pleistocene debris flow deposits in the Vipava Valley, SW Slovenia. In: VLAHOVIĆ, Igor (ur.). e-Abstracts book, 22nd IAS Meeting of Sedimentology- Opatija 2003. Zagreb: Institute of geology, 161.

Popit T (2016) Transport mechanisms and depositional processes of Quaternary slope deposit in Rebrnice area : doctoral thesis. Ljubljana. 345 pp. <http://drugg.fgg.uni-lj.si/5433/>

Popit T, Rožič, B, Verbovšek, T (2016) Geomorphometric characteristic of selected fossil landslides in the Vipava valley, SW Slovenia. V: *Conference 2016, 7th to 9th December 2016, Arup, London. Abstract book : the future of geological remote sensing : innovation and challenges*. London: Geological Remote Sensing Group, 41.

Popit T, Jež J, Verbovšek T (2017) Mass movement processes of Quaternary deposits in the Vipava Valley, SW Slovenia. 4th World Landslide Forum proceedings by Springer Nature publishing, in press.

Prager C, Zangerl C, Patzelt G, Brandner R (2008) Age distribution of fossil landslides in the Tyrol (Austria) and its surrounding areas. *Natural Hazards and Earth System Sciences* 8: 377-407.

Pulko, B., Majes, B. & Mikoš, M. Landslides (2014) Reinforced concrete shafts for the structural mitigation of large deep-seated landslides : an experience from the Macesnik and the Slano blato landslides (Slovenia). *Landslides*, 81-91, doi:10.1007/s10346-012-0372-211

Ribičič M, Kočevar M (2002) The final remediation of the landslide Slano blato above settlement Lokavec at Ajdovščina. *Geologija* 45(2): 525-530 (in Slovenian)

Schmid SM, Fügenschuh B, Kissling E, Schuster R (2004) Tectonic map and overall architecture of the Alpine orogen. *Eclogae Geologicae Helvetiae* 97(1): 93-117.

Silvano S, Cucchi F, D'Agostino V, Marchi L (2004) Attività tecnico scientifica per l'analisi delle condizioni di rischio idrogeologico a seguito degli eventi alluvionali del 29 Agosto 2003 in località Cucco in comune di Malborghetto Valbruna e per la definizione degli interventi indispensabili per la messa in sicurezza delle abitazioni soggetto a pericolo alluvionale. Rapporto interno elaborato per la Protezione Civile della Regione Autonoma Friuli Venezia Giulia.

Sodnik J, Vrečko A, Podobnikar T, Mikoš M (2012) Digital terrain models and mathematical modelling of debris flows. *Geodetski vestnik*, 56/4, 826-837, [http://www.geodetski-vestnik.com/56/4/gv56-4\\_826-837.pdf](http://www.geodetski-vestnik.com/56/4/gv56-4_826-837.pdf).

Sodnik J, Kumelj Š, Peternel T, Jež J, Maček M (2017) Identification of landslides as debris flow sources using multi model approach based on field survey – Koroška Bela, Slovenia. *Proceedings of the 4th World Landslide Forum, Ljubljana, 29 May – 2 June 2017* (in press).

Till A (1907) Das große Naturereignis von 1348 und die Bergstürze des Dobratsch. *Mitteilungen der k.k. Geographischen Gesellschaft in Wien* 10-11: 534-645.

van Husen D (1987) Die Ostalpen in den Eiszeiten. *Veröffentlichung der Geologischen Bundesanstalt* 2, 24pp.

Verbovšek T, Kočevar, M, Benko, I, Maček, M, Petkovšek, A (2017a) Monitoring of the Stogovce landslide slope movements with GEASENSE GNSS probes, SW Slovenia, 4th World Landslide Forum proceedings by Springer Nature publishing, in press.

Verbovšek T, Košir A, Teran M, Zajc M, Popit T (2017b) Volume determination of the Selo landslide complex (SW Slovenia): integrating field mapping, ground penetrating radar and GIS approaches. *Landslides*, doi: 10.1007/s10346-017-0815-x.



The image shows an invitation card for the 3rd Regional Symposium on Landslides in the Adriatic-Balkan Region, ReSyLAB 2017. The card features a background image of a landslide. The text on the card includes the title, dates (11-13 October 2017), location (Ljubljana, Slovenia), and an invitation from the Geological Survey of Slovenia and the University of Ljubljana. The card also includes the logos of the Adriatic-Balkan Network (ABN) and GeoZS.

**ReSyLAB 2017**  
**3<sup>rd</sup> Regional Symposium on Landslides in the Adriatic-Balkan Region**  
**11 - 13 October 2017 Ljubljana, Slovenia**

**INVITATION**

On behalf of the Geological Survey of Slovenia and University of Ljubljana (Faculty of Civil and Geodetic Engineering and Faculty of Natural Sciences and Engineering), it is our pleasure to invite you to take part in the 3<sup>rd</sup> Regional Symposium on Landslides in the Adriatic-Balkan Region, **ReSyLAB 2017** ([www.geo-zs.si/ReSyLAB2017/](http://www.geo-zs.si/ReSyLAB2017/)) that will take place in Ljubljana (Slovenia), 11-13 October 2017. The symposium aims to gather the ICL ABN (International Consortium on Landslides, Adriatic-Balkan Network) members, as well as other respected experts, professionals and researchers from the region and beyond (including both, academic and industrial sector) that can relate to the symposium topic and rationale.

We look forward to welcoming you in Ljubljana in October 2017.

Yours Sincerely,  
Dr. Mateja Jemec Auflič  
Geological Survey of Slovenia  
On behalf of Organizing Committee of 3<sup>rd</sup> Regional Symposium on Landslides in Adriatic-Balkan Region



SLOVENIAN GEOLOGICAL SOCIETY – SGD (<https://sites.google.com/a/geo.ntf.uni-lj.si/sgd/>)

Slovenian Geological Society (SGD) is a professional association of Slovenian geologists that brings together researchers, professional and educational workers and amateur geologists. The overall objective of SGD is contributing to the advancement of science and practice in the field of all branches of geology and related disciplines. To meet this goal, SGD performs the following activities: a) Organization of public lectures, field trips, and scientific meetings; b) Popularization of geology and integration of geological sciences in primary and secondary school curricula through popular scientific lectures, papers, brochures, exhibitions and excursions; c) Cooperation with universities, research organizations, public institutions and institutes, companies and persons whose areas of expertise involve different branches of geological sciences; d) Contribution in efforts to protect the environment; e) Contributing to the preparation of legislative acts in the field of geology; f) Cooperation with other professional associations in Slovenia and abroad.

The SGD interacts with national and international organizations as a member of EFG (European Federation of Geologists), INQUA (International Union for Quaternary Research), EMU (European Mineralogical Union), and SIZ (Slovenian Engineering Association).



University of Ljubljana  
Faculty of Civil and Geodetic Engineering

University  
of Ljubljana  
Faculty of Natural Sciences and Engineering

